



 **STiLAS**

LAS

STiLAS

STiL

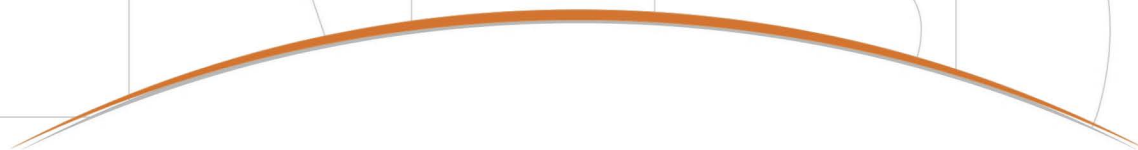

 **STiLAS**



 **STILAS**



– Dış Aydınlatma Armatürleri | Exterior Luminaires –

	SAYFA PAGE
– Tavan Armatürleri Ceiling Luminaires	– 04
– Gömme Duvar Armatürleri Recessed Wall Luminaires	– 14
– Sıva Üstü Duvar Armatürleri Surface Wall Luminaires	– 28
– Projektörler Projectors	– 58
– Gömme Yer Armatürleri In-Ground Luminaires	– 70
– Kısa Tip Bahçe-Park Armatürleri Bollards	– 90
– Aydınlatma Direkleri Pole-Top Luminaires	– 140



STILAS

Dış Aydınlatma Armatürleri | Exterior Luminaires



Tavan Armatürleri

Ceiling Luminaires



LED Tipi LED Type	Renk Isısı Color Temperature	Toplam Güç Total Power	Akım Current	Voltaj Voltage	Toplam Lümen Total Lumen
Middle Power LED	3000K	16W	20mA	220V AC	1320lm
Middle Power LED	4000K	16W	20mA	220V AC	1460lm

Malzeme : Alüminyum enjeksiyon gövde ve pres cam
Renk : Füme, Metalik Gri, Siyah
 Armatürün yüzeyine elektrostatik toz boyadan önce korozyon direncini arttırıcı zincrim uygulanır.
 LED sürücüsü dahil

Material : Die-cast aluminium body and pressed glass
Color : Graphite, Metallic Grey, Black
 For corrosion resistance, zincrim applied to surface of the luminaire before electrostatic powder coating
 With LED driver

535L56

MIDDLE POWER LED

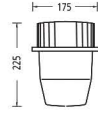

IP 64



530117



MAX.20W. TC-TSE E27



LED Tipi LED Type	Renk Isısı Color Temperature	Toplam Güç Total Power	Akım Current	Voltaj Voltage	Toplam Lümen Total Lumen
Middle Power LED	3000K	16W	20mA	220V AC	1320lm
Middle Power LED	4000K	16W	20mA	220V AC	1460lm

Malzeme : Alüminyum enjeksiyon gövde, pres cam ve çelik tel kafes
Renk : Füme, Metalik Gri, Siyah
 Armatürün yüzeyine elektrostatik toz boyadan önce korozyon direncini arttırıcı zincrim uygulanır.
 LED sürücüsü dahil

Material : Die-cast aluminium body, pressed glass and steel cage
Color : Graphite, Metallic Grey, Black
 For corrosion resistance, zincrim applied to surface of the luminaire before electrostatic powder coating
 With LED driver

535L57

MIDDLE POWER LED

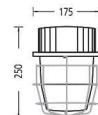

IP 64



530118



MAX.20W. TC-TSE E27



LED Tipi LED Type	Renk Isısı Color Temperature	Toplam Güç Total Power	Akım Current	Voltaj Voltage	Toplam Lümen Total Lumen
Middle Power LED	3000K	8W	20mA	220V AC	565lm
Middle Power LED	4000K	8W	20mA	220V AC	640lm

Malzeme : Alüminyum enjeksiyon gövde ve pres cam
Renk : Füme, Metalik Gri, Siyah
Armatürün yüzeyine elektrostatik toz boyadan önce korozyon direncini arttırıcı zincoprım uygulanır.
LED sürücüsü dahil

Material : Die-cast aluminium body and pressed glass
Color : Graphite, Metallic Grey, Black
For corrosion resistance, zincoprım applied to surface of the luminaire before electrostatic powder coating
With LED driver

535L28

MIDDLE POWER LED



IP 54



440115



MAX.28W. A ECO E27



LED Tipi LED Type	Renk Isısı Color Temperature	Toplam Güç Total Power	Akım Current	Voltaj Voltage	Toplam Lümen Total Lumen
Middle Power LED	3000K	16W	20mA	220V AC	1320lm
Middle Power LED	4000K	16W	20mA	220V AC	1460lm

Malzeme : Alüminyum enjeksiyon gövde ve pres cam
Renk : Füme, Metalik Gri, Siyah
Armatürün yüzeyine elektrostatik toz boyadan önce korozyon direncini arttırıcı zincoprım uygulanır.
LED sürücüsü dahil

Material : Die-cast aluminium body and pressed glass
Color : Graphite, Metallic Grey, Black
For corrosion resistance, zincoprım applied to surface of the luminaire before electrostatic powder coating
With LED driver

535L29

MIDDLE POWER LED



IP 54



440116



MAX.42W. A ECO E27



LED Tipi LED Type	Renk Isısı Color Temperature	Toplam Güç Total Power	Voltaj Voltage	Toplam Lümen Total Lumen
LED Ampul / Bulb	2700K	4,8W	220V AC	350lm
LED Ampul / Bulb	6500K	4,8W	220V AC	390lm

Malzeme : Alüminyum enjeksiyon gövde, ısıya dayanıklı cam
Renk : Füme, Metalik Gri, Siyah
 Armatürün yüzeyine elektrostatik toz boyadan önce korozyon direncini artırıcı zincrim uygulanır.
 LED sürücüsü dahil

Material : Die-cast aluminium body, tempered glass
Color : Graphite, Metallic Grey, Black
 For corrosion resistance, zincrim applied to surface of the luminaire before electrostatic powder coating
 With LED driver

535L61



IP 54



LED Tipi LED Type	Renk Isısı Color Temperature	Toplam Güç Total Power	Akım Current	Voltaj Voltage	Toplam Lümen Total Lumen
Power LED	3000K	5W	500mA	220V AC	474lm
Power LED	4000K	5W	500mA	220V AC	529lm
Power LED	6500K	5W	500mA	220V AC	596lm

LED Tipi LED Type	Renk Isısı Color Temperature	Toplam Güç Total Power	Akım Current	Voltaj Voltage	Toplam Lümen Total Lumen
Power LED	3000K	10W	500mA	220V AC	948lm
Power LED	4000K	10W	500mA	220V AC	1058lm
Power LED	6500K	10W	500mA	220V AC	1192lm

Malzeme : Alüminyum profil ve enjeksiyon gövde, ısıya dayanıklı cam
Renk : Füme, Metalik Gri, Siyah
 Armatürün yüzeyine elektrostatik toz boyadan önce korozyon direncini artırıcı zincrim uygulanır.
 LED sürücüsü dahil

Material : Die-cast aluminium and extruded body, tempered glass
Color : Graphite, Metallic Grey, Black
 For corrosion resistance, zincrim applied to surface of the luminaire before electrostatic powder coating
 With LED driver

535L09

535L60

POWER LED

POWER LED



IP 65





LED Tipi LED Type	Renk Isısı Color Temperature	Toplam Güç Total Power	Akım Current	Voltaj Voltage	Toplam Lümen Total Lumen
Power LED	3000K	15W	500mA	220V AC	1422lm
Power LED	4000K	15W	500mA	220V AC	1587lm
Power LED	6500K	15W	500mA	220V AC	1788lm

LED Tipi LED Type	Renk Isısı Color Temperature	Toplam Güç Total Power	Akım Current	Voltaj Voltage	Toplam Lümen Total Lumen
Power LED	3000K	20W	500mA	220V AC	1896lm
Power LED	4000K	20W	500mA	220V AC	2116lm
Power LED	6500K	20W	500mA	220V AC	2384lm

Malzeme : Alüminyum profil ve enjeksiyon gövde, ısıya dayanıklı cam

Renk : Füme, Metalik Gri, Siyah

Armatürün yüzeyine elektrostatik toz boyadan önce korozyon direncini artırıcı zincrim uygulanır.
LED sürücüsü dahil

Material : Die-cast aluminium and extruded body, tempered glass

Color : Graphite, Metallic Grey, Black

For corrosion resistance, zincrim applied to surface of the luminaire before electrostatic powder coating
With LED driver

535L01

POWER LED

535L12

POWER LED

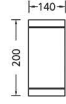

IP 65



530115



MAX.75W. QPAR30 E27



LED Tipi LED Type	Renk Isısı Color Temperature	Toplam Güç Total Power	Akım Current	Voltaj Voltage	Toplam Lümen Total Lumen
Power LED	3000K	45W	700mA	220V AC	3687lm
Power LED	4000K	45W	700mA	220V AC	4140lm
Power LED	6500K	45W	700mA	220V AC	4630lm

Malzeme : Alüminyum profil ve enjeksiyon gövde, ısıya dayanıklı cam

Renk : Füme, Metalik Gri, Siyah

Armatürün yüzeyine elektrostatik toz boyadan önce korozyon direncini artırıcı zincrim uygulanır.
LED sürücüsü dahil

Material : Die-cast aluminium and extruded body, tempered glass

Color : Graphite, Metallic Grey, Black

For corrosion resistance, zincrim applied to surface of the luminaire before electrostatic powder coating
With LED driver

535L15

POWER LED

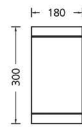

IP 65



538107



MAX.35-70W. HIT-CE G12





7800 Otel - Çeşme/İZMİR



LED Tipi LED Type	Renk Isısı Color Temperature	Toplam Güç Total Power	Akım Current	Voltaj Voltage	Toplam Lümen Total Lumen
Power LED	3000K	10W	500mA	220V AC	948lm
Power LED	4000K	10W	500mA	220V AC	1058lm
Power LED	6500K	10W	500mA	220V AC	1192lm

Malzeme : Alüminyum profil ve enjeksiyon gövde, ısıya dayanıklı cam
Renk : Füme, Metalik Gri, Siyah
 Armatürün yüzeyine elektrostatik toz boyadan önce korozyon direncini artırıcı zincoprım uygulanır.
 LED sürücüsü dahil

Material : Die-cast aluminium and extruded body, tempered glass
Color : Graphite, Metallic Grey, Black
 For corrosion resistance, zincoprım applied to surface of the luminaire before electrostatic powder coating
 With LED driver

535L18

POWER LED



IP 65



LED Tipi LED Type	Renk Isısı Color Temperature	Toplam Güç Total Power	Akım Current	Voltaj Voltage	Toplam Lümen Total Lumen
Power LED	3000K	20W	500mA	220V AC	1896lm
Power LED	4000K	20W	500mA	220V AC	2116lm
Power LED	6500K	20W	500mA	220V AC	2384lm

Malzeme : Alüminyum profil ve enjeksiyon gövde, ısıya dayanıklı cam
Renk : Füme, Metalik Gri, Siyah
 Armatürün yüzeyine elektrostatik toz boyadan önce korozyon direncini artırıcı zincoprım uygulanır.
 LED sürücüsü dahil

Material : Die-cast aluminium and extruded body, tempered glass
Color : Graphite, Metallic Grey, Black
 For corrosion resistance, zincoprım applied to surface of the luminaire before electrostatic powder coating
 With LED driver

535L21

POWER LED



IP 65



538115



MAX.20W. HIT-TC-CE GU6.5

530119



MAX.75W. QPAR30 E27



LED Tipi LED Type	Renk Isısı Color Temperature	Toplam Güç Total Power	Akım Current	Voltaj Voltage	Toplam Lümen Total Lumen
Power LED	3000K	30W	700mA	220V AC	2458lm
Power LED	4000K	30W	700mA	220V AC	2760lm
Power LED	6500K	30W	700mA	220V AC	3087lm

Malzeme : Alüminyum profil ve enjeksiyon gövde, ısıya dayanıklı cam
Renk : Füme, Metalik Gri, Siyah
 Armatürün yüzeyine elektrostatik toz boyadan önce korozyon direncini artırıcı zincrim uygulanır.
 LED sürücüsü dahil

Material : Die-cast aluminium and extruded body, tempered glass
Color : Graphite, Metallic Grey, Black
 For corrosion resistance, zincrim applied to surface of the luminaire before electrostatic powder coating
 With LED driver

535L55

POWER LED

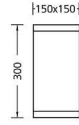

IP 65



538116



MAX.35-70W. HIT-CE G12



LED Tipi LED Type	Renk Isısı Color Temperature	Toplam Güç Total Power	Akım Current	Voltaj Voltage	Toplam Lümen Total Lumen
Power LED	3000K	45W	700mA	220V AC	3687lm
Power LED	4000K	45W	700mA	220V AC	4140lm
Power LED	6500K	45W	700mA	220V AC	4630lm

Malzeme : Alüminyum profil ve enjeksiyon gövde, ısıya dayanıklı cam
Renk : Füme, Metalik Gri, Siyah
 Armatürün yüzeyine elektrostatik toz boyadan önce korozyon direncini artırıcı zincrim uygulanır.
 LED sürücüsü dahil

Material : Die-cast aluminium and extruded body, tempered glass
Color : Graphite, Metallic Grey, Black
 For corrosion resistance, zincrim applied to surface of the luminaire before electrostatic powder coating
 With LED driver

535L59

POWER LED

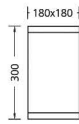

IP 65





STILAS

Dış Aydınlatma Armatürleri | Exterior Luminaires



Gömme Duvar Armatürleri Recessed Wall Luminaires

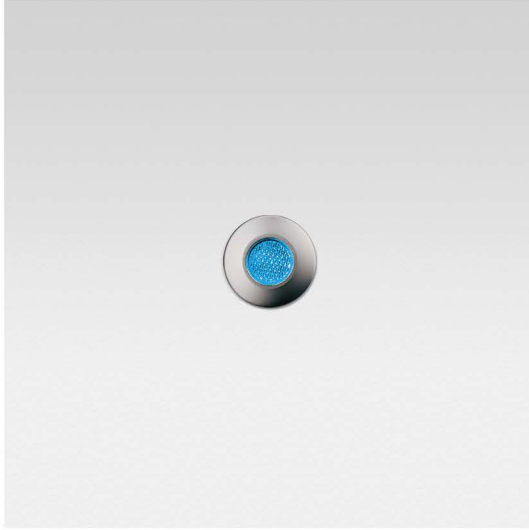

LED Tipi LED Type	Renk Isısı Color Temperature	Toplam Güç Total Power	Akım Current	Voltaj Voltage	Toplam Lümen Total Lumen
SMD LED	3000K	1W	350mA	220V AC	90lm
SMD LED	5000K	1W	350mA	220V AC	116lm

Malzeme : Plastik enjeksiyon gövde ve paslanmaz çelik ön kapak ve plastik enjeksiyon gövde, ısıya dayanıklı cam, galvanizli metal ankastre montaj kasası

Renk : Mat Çelik
Armatürün yüzeyine elektrostatik toz boyadan önce korozyon direncini arttırıcı zincoprım uygulanır. LED sürücüsü dahil

Material : Plastic injection body and stainless-steel front frame, tempered glass, galvanized pressed steel recessed box

Color : Matt Steel
For corrosion resistance, zincoprım applied to surface of the luminaire before electrostatic powder coating With LED driver

504L01

SMD LED



9MNK15

Ankastre Montaj Kasası / Recessed Box



IP 65

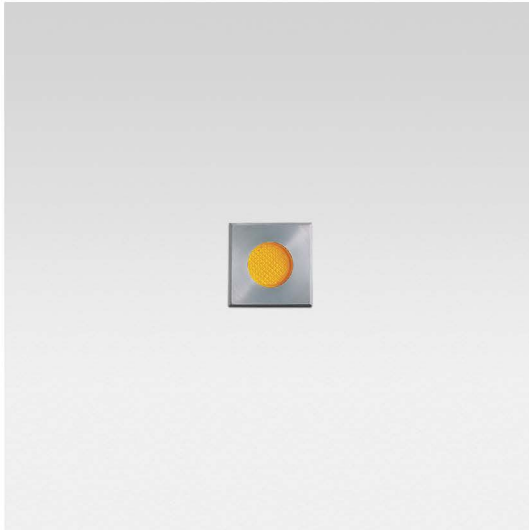

LED Tipi LED Type	Renk Isısı Color Temperature	Toplam Güç Total Power	Akım Current	Voltaj Voltage	Toplam Lümen Total Lumen
SMD LED	3000K	1W	350mA	220V AC	90lm
SMD LED	5000K	1W	350mA	220V AC	116lm

Malzeme : Plastik enjeksiyon gövde ve paslanmaz çelik ön kapak ve plastik enjeksiyon gövde, ısıya dayanıklı cam, galvanizli metal ankastre montaj kasası

Renk : Mat Çelik
Armatürün yüzeyine elektrostatik toz boyadan önce korozyon direncini arttırıcı zincoprım uygulanır. LED sürücüsü dahil

Material : Plastic injection body and stainless-steel front frame, tempered glass, galvanized pressed steel recessed box

Color : Matt Steel
For corrosion resistance, zincoprım applied to surface of the luminaire before electrostatic powder coating With LED driver

504L02

SMD LED

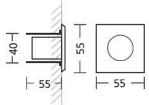

9MNK15

Ankastre Montaj Kasası / Recessed Box



IP 65



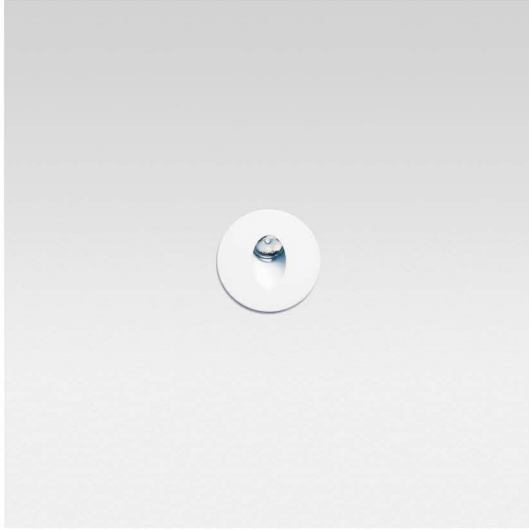

LED Tipi LED Type	Renk Isısı Color Temperature	Toplam Güç Total Power	Akım Current	Voltaj Voltage	Toplam Lümen Total Lumen
Power LED	3000K	3W	700mA	220V AC	351lm
Power LED	4000K	3W	700mA	220V AC	408lm
Power LED	6500K	3W	700mA	220V AC	441lm

Malzeme : Alüminyum enjeksiyon gövde ve ısıya dayanıklı cam, galvanizli metal ankastre montaj kasası

Renk : Füme, Metalik Gri, Siyah
Armatürün yüzeyine elektrostatik toz boyadan önce korozyon direncini artırıcı zincoprım uygulanır.
LED sürücüsü dahil

Material : Die-cast aluminium body and tempered glass, galvanized pressed steel recessed box
Color : Graphite, Metallic Grey, Black
For corrosion resistance, zincoprım applied to surface of the luminaire before electrostatic powder coating
With LED driver

504L13

POWER LED

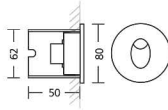

9MNK15

Ankastre Montaj Kasası / Recessed Box



IP 54



LED Tipi LED Type	Renk Isısı Color Temperature	Toplam Güç Total Power	Akım Current	Voltaj Voltage	Toplam Lümen Total Lumen
Power LED	3000K	3W	700mA	220V AC	351lm
Power LED	4000K	3W	700mA	220V AC	408lm
Power LED	6500K	3W	700mA	220V AC	441lm

Malzeme : Alüminyum enjeksiyon gövde ve ısıya dayanıklı cam, galvanizli metal ankastre montaj kasası

Renk : Füme, Metalik Gri, Siyah
Armatürün yüzeyine elektrostatik toz boyadan önce korozyon direncini artırıcı zincoprım uygulanır.
LED sürücüsü dahil

Material : Die-cast aluminium body and tempered glass, galvanized pressed steel recessed box
Color : Graphite, Metallic Grey, Black
For corrosion resistance, zincoprım applied to surface of the luminaire before electrostatic powder coating
With LED driver

504L14

POWER LED

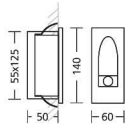

9MNK02

Ankastre Montaj Kasası / Recessed Box



IP 54





LED Tipi LED Type	Renk Isısı Color Temperature	Toplam Güç Total Power	Akım Current	Voltaj Voltage	Toplam Lümen Total Lumen
Middle Power LED	3000K	4W	116mA	220V AC	305lm
Middle Power LED	4000K	4W	116mA	220V AC	365lm

Malzeme : Alüminyum enjeksiyon gövde ve ısıya dayanıklı cam, galvanizli metal ankastre montaj kasası
Renk : Füme, Metalik Gri, Siyah
 Armatürün yüzeyine elektrostatik toz boyadan önce korozyon direncini artırıcı zincoprım uygulanır. LED sürücüsü dahil
Material : Die-cast aluminium body and tempered glass, galvanized pressed steel recessed box
Color : Graphite, Metallic Grey, Black
 For corrosion resistance, zincoprım applied to surface of the luminaire before electrostatic powder coating With LED driver

504L03

MIDDLE POWER LED

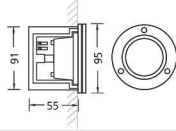

9MNK01

Ankastre Montaj Kasası / Recessed Box



IP 65



502101



MAX.25W. QT14 G9



LED Tipi LED Type	Renk Isısı Color Temperature	Toplam Güç Total Power	Akım Current	Voltaj Voltage	Toplam Lümen Total Lumen
Middle Power LED	3000K	4W	116mA	220V AC	305lm
Middle Power LED	4000K	4W	116mA	220V AC	365lm

Malzeme : Alüminyum enjeksiyon gövde ve ısıya dayanıklı cam, galvanizli metal ankastre montaj kasası
Renk : Füme, Metalik Gri, Siyah
 Armatürün yüzeyine elektrostatik toz boyadan önce korozyon direncini artırıcı zincoprım uygulanır. LED sürücüsü dahil
Material : Die-cast aluminium body and tempered glass, galvanized pressed steel recessed box
Color : Graphite, Metallic Grey, Black
 For corrosion resistance, zincoprım applied to surface of the luminaire before electrostatic powder coating With LED driver

504L12

MIDDLE POWER LED

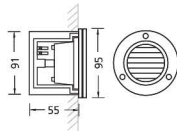

9MNK01

Ankastre Montaj Kasası / Recessed Box



IP 65



502102



MAX.25W. QT14 G9



LED Tipi LED Type	Renk Isısı Color Temperature	Toplam Güç Total Power	Akım Current	Voltaj Voltage	Toplam Lümen Total Lumen
COB LED	3000K	5W	350mA	220V AC	569lm
COB LED	4000K	5W	350mA	220V AC	600lm
COB LED	6500K	5W	350mA	220V AC	674lm

Malzeme : Alüminyum enjeksiyon gövde ve akrilik difüzör, galvanizli metal ankastre montaj kasası
Renk : Füme, Metalik Gri, Siyah
Armatürün yüzeyine elektrostatik toz boyadan önce korozyon direncini artırıcı zincoprım uygulanır.
LED sürücüsü dahil

Material : Die-cast aluminium body and acrylic diffuser, galvanized pressed steel recessed box
Color : Graphite, Metallic Grey, Black
For corrosion resistance, zincoprım applied to surface of the luminaire before electrostatic powder coating
With LED driver

504L08

COB LED

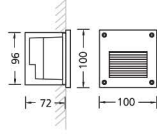

9MNK33

Ankastre Montaj Kasası / Recessed Box



IP 65



502104



MAX.25W. QT14 G9



1m Uzunluk için

COLOR TEMPERATURE	TYP. CRI	LED QTY.	VOLT	WATT	LUMEN
3000K	85	24	12V	11W	990lm
4000K	85	24	12V	11W	1085lm
6500K	85	24	12V	11W	990lm

Malzeme : Alüminyum profil ve enjeksiyon gövde, akrilik ön kapak
Renk : Metalik Gri, Füme, Beyaz, Siyah
Elektronik balast gövdeye montajlıdır

Material : Extruded aluminium and die-cast body, acrylic diffuser
Color : Metallic Grey, Graphite, White, Black
Built-in electronic ballast

ÖZEL ÜRÜN

MIDDLE POWER LED



IP 20





LED Tipi LED Type	Renk Isısı Color Temperature	Toplam Güç Total Power	Akım Current	Voltaj Voltage	Toplam Lümen Total Lumen
Middle Power LED	3000K	11W	116mA	220V AC	953lm
Middle Power LED	4000K	11W	116mA	220V AC	1044lm

Malzeme : Alüminyum enjeksiyon gövde, ısıya dayanıklı cam, galvanizli metal ankastre montaj kasası
Renk : Füme, Metalik Gri, Siyah
 Armatürün yüzeyine elektrostatik toz boyadan önce korozyon direncini artırıcı zincoprım uygulanır.
 LED sürücüsü dahil

Material : Die-cast aluminium body, tempered glass, galvanized pressed steel recessed box
Color : Graphite, Metallic Grey, Black
 For corrosion resistance, zincoprım applied to surface of the luminaire before electrostatic powder coating
 With LED driver

504L11

MIDDLE POWER LED

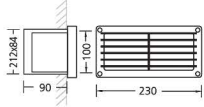

9MNK03

Ankastre Montaj Kasası / Recessed Box



IP 65



508102



MAX.18W.TC-D G24d2



LED Tipi LED Type	Renk Isısı Color Temperature	Toplam Güç Total Power	Akım Current	Voltaj Voltage	Toplam Lümen Total Lumen
Power LED	3000K	22W	500mA	220V AC	1905lm
Power LED	4000K	22W	500mA	220V AC	2087lm
Power LED	6500K	22W	500mA	220V AC	2194lm

Malzeme : Alüminyum enjeksiyon gövde ve akrilik difüzör, galvanizli metal ankastre montaj kasası
Renk : Füme, Metalik Gri, Siyah
 Armatürün yüzeyine elektrostatik toz boyadan önce korozyon direncini artırıcı zincoprım uygulanır.
 LED sürücüsü dahil

Material : Die-cast aluminium body and acrylic diffuser, galvanized pressed steel recessed box
Color : Graphite, Metallic Grey, Black
 For corrosion resistance, zincoprım applied to surface of the luminaire before electrostatic powder coating
 With LED driver

504L10

POWER LED

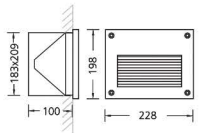

9MNK34

Ankastre Montaj Kasası / Recessed Box



IP 65



508106



MAX.18W.TC-D G24d2





LED Tipi LED Type	Renk Isısı Color Temperature	Toplam Güç Total Power	Akım Current	Voltaj Voltage	Toplam Lümen Total Lumen
COB LED	3000K	8W	300mA	220V AC	669lm
COB LED	4000K	8W	300mA	220V AC	700lm

Malzeme : Alüminyum enjeksiyon gövde ve akrilik difüzör, galvanizli metal ankastre montaj kasası
Renk : Füme, Metalik Gri, Siyah
 Armatürün yüzeyine elektrostatik toz boyadan önce korozyon direncini artırıcı zincoprım uygulanır.
 LED sürücüsü dahil

Material : Die-cast aluminium body and acrylic diffuser, galvanized pressed steel recessed box
Color : Graphite, Metallic Grey, Black
 For corrosion resistance, zincoprım applied to surface of the luminaire before electrostatic powder coating
 With LED driver

504L04

COB LED

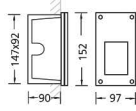

9MNK02

Ankastre Montaj Kasası / Recessed Box



IP 65



500101



MAX.40W. QT14 G9

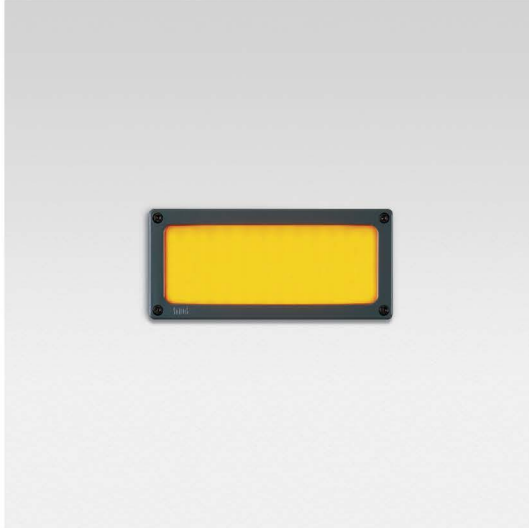

LED Tipi LED Type	Renk Isısı Color Temperature	Toplam Güç Total Power	Akım Current	Voltaj Voltage	Toplam Lümen Total Lumen
Middle Power LED	3000K	11W	116mA	220V AC	953lm
Middle Power LED	4000K	11W	116mA	220V AC	1044lm

Malzeme : Alüminyum enjeksiyon gövde, ısıya dayanıklı cam, galvanizli metal ankastre montaj kasası
Renk : Füme, Metalik Gri, Siyah
 Armatürün yüzeyine elektrostatik toz boyadan önce korozyon direncini artırıcı zincoprım uygulanır.
 LED sürücüsü dahil

Material : Die-cast aluminium body, tempered glass, galvanized pressed steel recessed box
Color : Graphite, Metallic Grey, Black
 For corrosion resistance, zincoprım applied to surface of the luminaire before electrostatic powder coating
 With LED driver

504L05

MIDDLE POWER LED

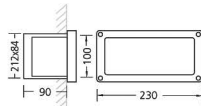

9MNK03

Ankastre Montaj Kasası / Recessed Box



IP 65



508101



MAX.18W.TC-D G24d2



LED Tipi LED Type	Renk Isısı Color Temperature	Toplam Güç Total Power	Akım Current	Voltaj Voltage	Toplam Lümen Total Lumen
Middle Power LED	3000K	11W	116mA	220V AC	953lm
Middle Power LED	4000K	11W	116mA	220V AC	1044lm

Malzeme : Paslanmaz çelik ön çerçeve ve plastik enjeksiyon gövde, asimetrik alüminyum reflektör, ısıya dayanıklı cam, galvanizli metal ankastre montaj kasası
Renk : Fülme, Metalik Gri, Siyah
 Armatürün yüzeyine elektrostatik toz boyadan önce korozyon direncini arttırıcı zincoprım uygulanır. LED sürücüsü dahil

Material : Stainless-steel front frame and plastic injection body, tempered glass, galvanized pressed steel recessed box
Color : Graphite, Metallic Grey, Black
 For corrosion resistance, zincoprım applied to surface of the luminaire before electrostatic powder coating With LED driver

504L06

MIDDLE POWER LED

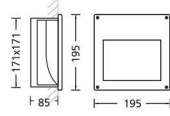

9MNK04

Ankastre Montaj Kasası / Recessed Box



IP 65



508103



MAX.10W.TC-D G24d1



LED Tipi LED Type	Renk Isısı Color Temperature	Toplam Güç Total Power	Akım Current	Voltaj Voltage	Toplam Lümen Total Lumen
Middle Power LED	3000K	15W	116mA	220V AC	1422lm
Middle Power LED	4000K	15W	116mA	220V AC	1587lm

Malzeme : Paslanmaz çelik ön çerçeve ve plastik enjeksiyon gövde, asimetrik alüminyum reflektör, ısıya dayanıklı cam, galvanizli metal ankastre montaj kasası
Renk : Fülme, Metalik Gri, Siyah
 Armatürün yüzeyine elektrostatik toz boyadan önce korozyon direncini arttırıcı zincoprım uygulanır. LED sürücüsü dahil

Material : Stainless-steel front frame and plastic injection body, tempered glass, galvanized pressed steel recessed box
Color : Graphite, Metallic Grey, Black
 For corrosion resistance, zincoprım applied to surface of the luminaire before electrostatic powder coating With LED driver

504L07

MIDDLE POWER LED

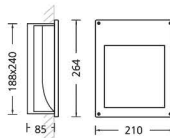

9MNK05

Ankastre Montaj Kasası / Recessed Box



IP 65



508104



MAX.13W.TC-D G24d1



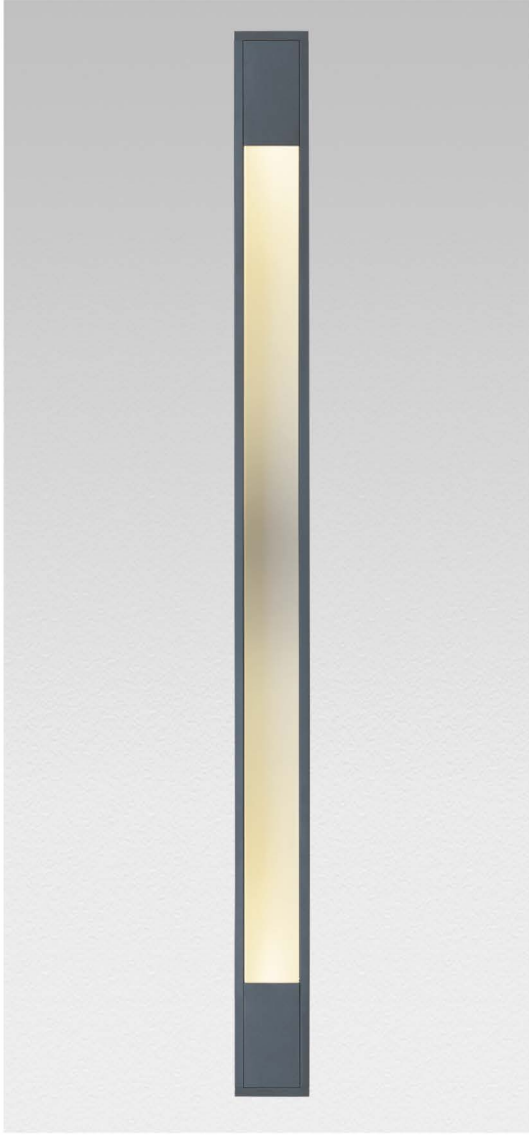

LED Tipi LED Type	Renk Isısı Color Temperature	Toplam Güç Total Power	Voltaj Voltage	Toplam Lümen Total Lumen
LED Ampul / Bulb	2700K	2x4,8W	220V AC	700lm
LED Ampul / Bulb	6500K	2x4,8W	220V AC	780lm

Malzeme : Alüminyum profil gövde, ısıya dayanıklı cam
Renk : Füme, Metalik Gri, Siyah
Armatürün yüzeyine elektrostatik toz boyadan önce korozyon direncini artırıcı zincoprım uygulanır.
LED sürücüsü dahil

Material : Aluminium extruded body, tempered glass
Color : Graphite, Metallic Grey, Black
For corrosion resistance, zincoprım applied to surface of the luminaire before electrostatic powder coating
With LED driver

504L16



POWER LED 2x4.8W. GU10



IP 54





LED Tipi LED Type	Renk Isısı Color Temperature	Toplam Güç Total Power	Voltaj Voltage	Toplam Lümen Total Lumen
LED Ampul / Bulb	2700K	2x4,8W	220V AC	700lm
LED Ampul / Bulb	6500K	2x4,8W	220V AC	780lm

Malzeme : Alüminyum profil gövde, ısıya dayanıklı cam
Renk : Füme, Metalik Gri, Siyah
Armatürün yüzeyine elektrostatik toz boyadan önce korozyon direncini artırıcı zincoprım uygulanır.
LED sürücüsü dahil

Material : Aluminium extruded body, tempered glass
Color : Graphite, Metallic Grey, Black
For corrosion resistance, zincoprım applied to surface of the luminaire before electrostatic powder coating
With LED driver

504L15



POWER LED 2x4.8W. GU10

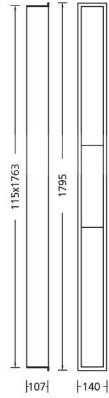

IP 54





Mandalin Villaları - Bodrum/ MUĞLA

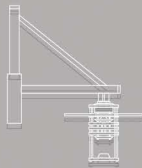

STILAS

Exterior Luminaires

Dış Aydınlatma Armatürleri

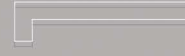
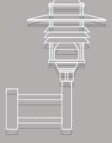

Sıva Üstü Duvar Armatürleri Surface Wall Luminaires



LED Tipi LED Type	Renk Isısı Color Temperature	Toplam Güç Total Power	Akım Current	Voltaj Voltage	Toplam Lümen Total Lumen
COB LED	3000K	8W	350mA	220V AC	669lm
COB LED	4000K	8W	350mA	220V AC	700lm



Malzeme : Alüminyum enjeksiyon gövde
Renk : Füme, Metalik Gri, Siyah
Armatürün yüzeyine elektrostatik toz boyadan önce korozyon direncini arttırıcı zincoprım uygulanır.
LED sürücüsü dahil

Material : Die-cast aluminium body
Color : Graphite, Metallic Grey, Black
For corrosion resistance, zincoprım applied to surface of the luminaire before electrostatic powder coating
With LED driver

534L58

COB LED

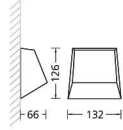

IP 54



LED Tipi LED Type	Renk Isısı Color Temperature	Toplam Güç Total Power	Akım Current	Voltaj Voltage	Toplam Lümen Total Lumen
Middle Power LED	3000K	8W	116mA	220V AC	565lm
Middle Power LED	4000K	8W	116mA	220V AC	640lm

Malzeme : Termoplastik enjeksiyon gövde ve polikarbonat koruyucu ön kapak
Renk : Füme, Metalik Gri, Siyah
Armatürün yüzeyine elektrostatik toz boyadan önce korozyon direncini arttırıcı zincoprım uygulanır.
LED sürücüsü dahil

Material : Thermoplastic injection body and polycarbonate diffuser
Color : Graphite, Metallic Grey, Black
For corrosion resistance, zincoprım applied to surface of the luminaire before electrostatic powder coating
With LED driver

534L48

MIDDLE POWER LED



IP 44



530113



MAX.20W. TC-TSE E27



LED Tipi LED Type	Renk Isısı Color Temperature	Toplam Güç Total Power	Akım Current	Voltaj Voltage	Toplam Lümen Total Lumen
Middle Power LED	3000K	16W	116mA	220V AC	1320lm
Middle Power LED	4000K	16W	116mA	220V AC	1460lm

Malzeme : Alüminyum enjeksiyon gövde ve pres cam
Renk : Füme, Metalik Gri, Siyah
 Armatürün yüzeyine elektrostatik toz boyadan önce korozyon direncini artırıcı zincrim uygulanır.
 LED sürücüsü dahil

Material : Die-cast aluminium body and pressed glass
Color : Graphite, Metallic Grey, Black
 For corrosion resistance, zincrim applied to surface of the luminaire before electrostatic powder coating
 With LED driver

534L49

MIDDLE POWER LED

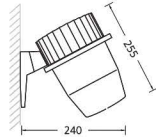

IP 64



530111



MAX.20W. TC-TSE E27



LED Tipi LED Type	Renk Isısı Color Temperature	Toplam Güç Total Power	Akım Current	Voltaj Voltage	Toplam Lümen Total Lumen
Middle Power LED	3000K	16W	116mA	220V AC	1320lm
Middle Power LED	4000K	16W	116mA	220V AC	1460lm

Malzeme : Alüminyum enjeksiyon gövde, pres cam ve çelik tel kafes
Renk : Füme, Metalik Gri, Siyah
 Armatürün yüzeyine elektrostatik toz boyadan önce korozyon direncini artırıcı zincrim uygulanır.
 LED sürücüsü dahil

Material : Die-cast aluminium body, pressed glass and steel cage
Color : Graphite, Metallic Grey, Black
 For corrosion resistance, zincrim applied to surface of the luminaire before electrostatic powder coating
 With LED driver

534L50

MIDDLE POWER LED



IP 64



530112



MAX.20W. TC-TSE E27



LED Tipi LED Type	Renk Isısı Color Temperature	Toplam Güç Total Power	Akım Current	Voltaj Voltage	Toplam Lümen Total Lumen
Middle Power LED	3000K	11W	116mA	220V AC	953lm
Middle Power LED	4000K	11W	116mA	220V AC	1044lm

Malzeme : Alüminyum enjeksiyon gövde ve pres cam
Renk : Füme, Metalik Gri, Siyah
 Armatürün yüzeyine elektrostatik toz boyadan önce korozyon direncini arttırıcı zincrim uygulanır.
 LED sürücüsü dahil

Material : Die-cast aluminium body and pressed glass
Color : Graphite, Metallic Grey, Black
 For corrosion resistance, zincrim applied to surface of the luminaire before electrostatic powder coating
 With LED driver

534L51

MIDDLE POWER LED

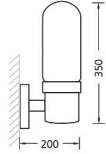

IP 44



530101



MAX.20W. TC-TSE E27



LED Tipi LED Type	Renk Isısı Color Temperature	Toplam Güç Total Power	Akım Current	Voltaj Voltage	Toplam Lümen Total Lumen
Middle Power LED	3000K	11W	116mA	220V AC	953lm
Middle Power LED	4000K	11W	116mA	220V AC	1044lm

Malzeme : Alüminyum enjeksiyon gövde ve pres cam
Renk : Füme, Metalik Gri, Siyah
 Armatürün yüzeyine elektrostatik toz boyadan önce korozyon direncini arttırıcı zincrim uygulanır.
 LED sürücüsü dahil

Material : Die-cast aluminium body and pressed glass
Color : Graphite, Metallic Grey, Black
 For corrosion resistance, zincrim applied to surface of the luminaire before electrostatic powder coating
 With LED driver

534L52

MIDDLE POWER LED

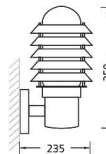

IP 44



530102



MAX.20W. TC-TSE E27



İş Bankası Sosyal Tesisleri - Çeşme/ İZMİR



LED Tipi LED Type	Renk Isısı Color Temperature	Toplam Güç Total Power	Akım Current	Voltaj Voltage	Toplam Lümen Total Lumen
Power LED	3000K	2x5W	500mA	220V AC	2x474lm
Power LED	4000K	2x5W	500mA	220V AC	2x529lm
Power LED	6500K	2x5W	500mA	220V AC	2x596lm

Malzeme : Alüminyum profil ve enjeksiyon gövde, ısıya dayanıklı cam ve optik lens

Renk : Füme, Metalik Gri, Siyah

Armatürün yüzeyine elektrostatik toz boyadan önce korozyon direncini artırıcı zincoprım uygulanır.
LED sürücüsü dahil

Material : Die-cast aluminium and extruded body, tempered glass and optic lens

Color : Graphite, Metallic Grey, Black

For corrosion resistance, zincoprım applied to surface of the luminaire before electrostatic powder coating
With LED driver

534L32

POWER LED

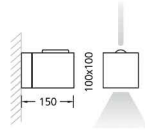

IP 65



530121



MAX.40W. QT 14 G9



LED Tipi LED Type	Renk Isısı Color Temperature	Toplam Güç Total Power	Akım Current	Voltaj Voltage	Toplam Lümen Total Lumen
Power LED	3000K	2x10W	500mA	220V AC	2x948lm
Power LED	4000K	2x10W	500mA	220V AC	2x1058lm
Power LED	6500K	2x10W	500mA	220V AC	2x1192lm

Malzeme : Alüminyum profil ve enjeksiyon gövde, ısıya dayanıklı cam ve optik lens

Renk : Füme, Metalik Gri, Siyah

Armatürün yüzeyine elektrostatik toz boyadan önce korozyon direncini artırıcı zincoprım uygulanır.
LED sürücüsü dahil

Material : Die-cast aluminium and extruded body, tempered glass and optic lens

Color : Graphite, Metallic Grey, Black

For corrosion resistance, zincoprım applied to surface of the luminaire before electrostatic powder coating
With LED driver

534L37

POWER LED

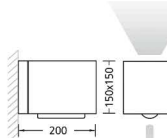

IP 65



538118



35W.-70W. HIT-CE G12



LED Tipi LED Type	Renk Isısı Color Temperature	Toplam Güç Total Power	Akım Current	Voltaj Voltage	Toplam Lümen Total Lumen
COB LED	3000K	16W	350mA	220V AC	1952lm
COB LED	4000K	16W	350mA	220V AC	2107lm

Malzeme : Alüminyum profil ve enjeksiyon gövde, akrilik difüzör
Renk : Füme, Metalik Gri, Siyah
Armatürün yüzeyine elektrostatik toz boyadan önce korozyon direncini artırıcı zincrim uygulanır.
LED sürücüsü dahil

Material : Die-cast aluminium and extruded body, acrylic diffuser
Color : Graphite, Metallic Grey, Black
For corrosion resistance, zincrim applied to surface of the luminaire before electrostatic powder coating
With LED driver

534L57

COB LED

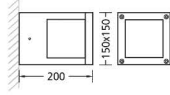

IP 65



530126



MAX.20W. TC-TSE E27





LED Tipi LED Type	Renk Isısı Color Temperature	Toplam Güç Total Power	Voltaj Voltage	Toplam Lümen Total Lumen
LED Ampul / Bulb	2700K	4,8W	220V AC	350lm
LED Ampul / Bulb	6500K	4,8W	220V AC	390lm

Malzeme : Alüminyum enjeksiyon gövde, ısıya dayanıklı cam
Renk : Füme, Metalik Gri, Siyah
 Armatürün yüzeyine elektrostatik toz boyadan önce korozyon direncini artırıcı zincrim uygulanır.
 LED sürücüsü dahil

Material : Die-cast aluminium body, tempered glass
Color : Graphite, Metallic Grey, Black
 For corrosion resistance, zincrim applied to surface of the luminaire before electrostatic powder coating
 With LED driver

534L59



POWER LED 1x4.8W. GU10

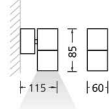

IP 65



530103



MAX.35W. QPAR16 GU10



LED Tipi LED Type	Renk Isısı Color Temperature	Toplam Güç Total Power	Voltaj Voltage	Toplam Lümen Total Lumen
LED Ampul / Bulb	2700K	2x4,8W	220V AC	700lm
LED Ampul / Bulb	6500K	2x4,8W	220V AC	780lm

Malzeme : Alüminyum enjeksiyon gövde, ısıya dayanıklı cam
Renk : Füme, Metalik Gri, Siyah
 Armatürün yüzeyine elektrostatik toz boyadan önce korozyon direncini artırıcı zincrim uygulanır.
 LED sürücüsü dahil

Material : Die-cast aluminium body, tempered glass
Color : Graphite, Metallic Grey, Black
 For corrosion resistance, zincrim applied to surface of the luminaire before electrostatic powder coating
 With LED driver

534L60



POWER LED 2x4.8W. GU10

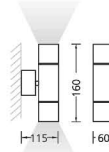

IP 65



530104



MAX.2x35W. QPAR16 GU10



Teras Villaları - Bodrum/MUĞLA



LED Tipi LED Type	Renk Isısı Color Temperature	Toplam Güç Total Power	Akım Current	Voltaj Voltage	Toplam Lümen Total Lumen
Power LED	3000K	5W	500mA	220V AC	474lm
Power LED	4000K	5W	500mA	220V AC	529lm
Power LED	6500K	5W	500mA	220V AC	596lm

LED Tipi LED Type	Renk Isısı Color Temperature	Toplam Güç Total Power	Akım Current	Voltaj Voltage	Toplam Lümen Total Lumen
Power LED	3000K	10W	500mA	220V AC	948lm
Power LED	4000K	10W	500mA	220V AC	1058lm
Power LED	6500K	10W	500mA	220V AC	1192lm

Malzeme : Alüminyum profil ve enjeksiyon gövde, ısıya dayanıklı cam

Renk : Füme, Metalik Gri, Siyah

Armatürün yüzeyine elektrostatik toz boyadan önce korozyon direncini artırıcı zincrim uygulanır.
LED sürücüsü dahil

Material : Die-cast aluminium and extruded body, tempered glass

Color : Graphite, Metallic Grey, Black

For corrosion resistance, zincrim applied to surface of the luminaire before electrostatic powder coating
With LED driver

534L10

534L61

POWER LED

POWER LED

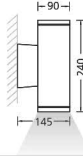

IP 65



LED Tipi LED Type	Renk Isısı Color Temperature	Toplam Güç Total Power	Akım Current	Voltaj Voltage	Toplam Lümen Total Lumen
Power LED	3000K	2x5W	500mA	220V AC	2x474lm
Power LED	4000K	2x5W	500mA	220V AC	2x529lm
Power LED	6500K	2x5W	500mA	220V AC	2x596lm

LED Tipi LED Type	Renk Isısı Color Temperature	Toplam Güç Total Power	Akım Current	Voltaj Voltage	Toplam Lümen Total Lumen
Power LED	3000K	2x10W	500mA	220V AC	2x948lm
Power LED	4000K	2x10W	500mA	220V AC	2x1058lm
Power LED	6500K	2x10W	500mA	220V AC	2x1192lm

Malzeme : Alüminyum profil ve enjeksiyon gövde, ısıya dayanıklı cam

Renk : Füme, Metalik Gri, Siyah

Armatürün yüzeyine elektrostatik toz boyadan önce korozyon direncini artırıcı zincrim uygulanır.
LED sürücüsü dahil

Material : Die-cast aluminium and extruded body, tempered glass

Color : Graphite, Metallic Grey, Black

For corrosion resistance, zincrim applied to surface of the luminaire before electrostatic powder coating
With LED driver

534L11

534L62

POWER LED

POWER LED



IP 65





LED Tipi LED Type	Renk Isısı Color Temperature	Toplam Güç Total Power	Akım Current	Voltaj Voltage	Toplam Lümen Total Lumen
Power LED	3000K	15W	500mA	220V AC	1422lm
Power LED	4000K	15W	500mA	220V AC	1587lm
Power LED	6500K	15W	500mA	220V AC	1788lm

LED Tipi LED Type	Renk Isısı Color Temperature	Toplam Güç Total Power	Akım Current	Voltaj Voltage	Toplam Lümen Total Lumen
Power LED	3000K	20W	500mA	220V AC	1896lm
Power LED	4000K	20W	500mA	220V AC	2116lm
Power LED	6500K	20W	500mA	220V AC	2384lm

Malzeme : Alüminyum profil ve enjeksiyon gövde, ısıya dayanıklı cam

Renk : Füme, Metalik Gri, Siyah

Armatürün yüzeyine elektrostatik toz boyadan önce korozyon direncini artırıcı zincrim uygulanır.
LED sürücüsü dahil

Material : Die-cast aluminium and extruded body, tempered glass

Color : Graphite, Metallic Grey, Black

For corrosion resistance, zincrim applied to surface of the luminaire before electrostatic powder coating
With LED driver

534L02

534L13

POWER LED

POWER LED

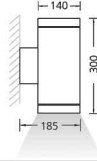

IP 65



530106



MAX.1x75W. QPAR30 E27



LED Tipi LED Type	Renk Isısı Color Temperature	Toplam Güç Total Power	Akım Current	Voltaj Voltage	Toplam Lümen Total Lumen
Power LED	3000K	2x15W	500mA	220V AC	2x1422lm
Power LED	4000K	2x15W	500mA	220V AC	2x1587lm
Power LED	6500K	2x15W	500mA	220V AC	2x1788lm

LED Tipi LED Type	Renk Isısı Color Temperature	Toplam Güç Total Power	Akım Current	Voltaj Voltage	Toplam Lümen Total Lumen
Power LED	3000K	2x20W	500mA	220V AC	2x1896lm
Power LED	4000K	2x20W	500mA	220V AC	2x2116lm
Power LED	6500K	2x20W	500mA	220V AC	2x2384lm

Malzeme : Alüminyum profil ve enjeksiyon gövde, ısıya dayanıklı cam

Renk : Füme, Metalik Gri, Siyah

Armatürün yüzeyine elektrostatik toz boyadan önce korozyon direncini artırıcı zincrim uygulanır.
LED sürücüsü dahil

Material : Die-cast aluminium and extruded body, tempered glass

Color : Graphite, Metallic Grey, Black

For corrosion resistance, zincrim applied to surface of the luminaire before electrostatic powder coating
With LED driver

534L03

534L14

POWER LED

POWER LED

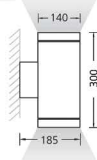

IP 65



530202



MAX.2x75W. QPAR30 E27



Teras Villaları - Bodrum/MUĞLA





LED Tipi LED Type	Renk Isısı Color Temperature	Toplam Güç Total Power	Akım Current	Voltaj Voltage	Toplam Lümen Total Lumen
Power LED	3000K	45W	700mA	220V AC	3687lm
Power LED	4000K	45W	700mA	220V AC	4140lm
Power LED	6500K	45W	700mA	220V AC	4630lm

Malzeme : Alüminyum profil ve enjeksiyon gövde, ısıya dayanıklı cam
Renk : Füme, Metalik Gri, Siyah
Armatürün yüzeyine elektrostatik toz boyadan önce korozyon direncini artırıcı zincoprım uygulanır.
LED sürücüsü dahil

Material : Die-cast aluminium and extruded body, tempered glass
Color : Graphite, Metallic Grey, Black
For corrosion resistance, zincoprım applied to surface of the luminaire before electrostatic powder coating
With LED driver

534L16

POWER LED

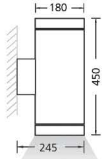

IP 65



538101



MAX.1x35W.-70W. HIT-CE G12



LED Tipi LED Type	Renk Isısı Color Temperature	Toplam Güç Total Power	Akım Current	Voltaj Voltage	Toplam Lümen Total Lumen
Power LED	3000K	2x45W	700mA	220V AC	3687lm
Power LED	4000K	2x45W	700mA	220V AC	4140lm
Power LED	6500K	2x45W	700mA	220V AC	4630lm

Malzeme : Alüminyum profil ve enjeksiyon gövde, ısıya dayanıklı cam
Renk : Füme, Metalik Gri, Siyah
Armatürün yüzeyine elektrostatik toz boyadan önce korozyon direncini artırıcı zincoprım uygulanır.
LED sürücüsü dahil

Material : Die-cast aluminium and extruded body, tempered glass
Color : Graphite, Metallic Grey, Black
For corrosion resistance, zincoprım applied to surface of the luminaire before electrostatic powder coating
With LED driver

534L17

POWER LED

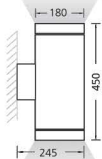

IP 65



538201



MAX.2x35W.-70W. HIT-CE G12



LED Tipi LED Type	Renk Isısı Color Temperature	Toplam Güç Total Power	Akım Current	Voltaj Voltage	Toplam Lümen Total Lumen
Power LED	3000K	10W	500mA	220V AC	948lm
Power LED	4000K	10W	500mA	220V AC	1058lm
Power LED	6500K	10W	500mA	220V AC	1192lm

Malzeme : Alüminyum profil ve enjeksiyon gövde, ısıya dayanıklı cam
Renk : Füme, Metalik Gri, Siyah
 Armatürün yüzeyine elektrostatik toz boyadan önce korozyon direncini artırıcı zincrim uygulanır.
 LED sürücüsü dahil

Material : Die-cast aluminium and extruded body, tempered glass
Color : Graphite, Metallic Grey, Black
 For corrosion resistance, zincrim applied to surface of the luminaire before electrostatic powder coating
 With LED driver

534L19

POWER LED

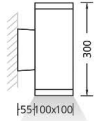

IP 65



LED Tipi LED Type	Renk Isısı Color Temperature	Toplam Güç Total Power	Akım Current	Voltaj Voltage	Toplam Lümen Total Lumen
Power LED	3000K	2x10W	500mA	220V AC	2x948lm
Power LED	4000K	2x10W	500mA	220V AC	2x1058lm
Power LED	6500K	2x10W	500mA	220V AC	2x1192lm

Malzeme : Alüminyum profil ve enjeksiyon gövde, ısıya dayanıklı cam
Renk : Füme, Metalik Gri, Siyah
 Armatürün yüzeyine elektrostatik toz boyadan önce korozyon direncini artırıcı zincrim uygulanır.
 LED sürücüsü dahil

Material : Die-cast aluminium and extruded body, tempered glass
Color : Graphite, Metallic Grey, Black
 For corrosion resistance, zincrim applied to surface of the luminaire before electrostatic powder coating
 With LED driver

534L20

POWER LED

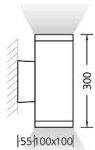

IP 65





LED Tipi LED Type	Renk Isısı Color Temperature	Toplam Güç Total Power	Akım Current	Voltaj Voltage	Toplam Lümen Total Lumen
Power LED	3000K	20W	500mA	220V AC	1896lm
Power LED	4000K	20W	500mA	220V AC	2116lm
Power LED	6500K	20W	500mA	220V AC	2384lm

LED Tipi LED Type	Renk Isısı Color Temperature	Toplam Güç Total Power	Akım Current	Voltaj Voltage	Toplam Lümen Total Lumen
Power LED	3000K	30W	700mA	220V AC	2458lm
Power LED	4000K	30W	700mA	220V AC	2760lm
Power LED	6500K	30W	700mA	220V AC	3087lm

Malzeme : Alüminyum profil ve enjeksiyon gövde, ısıya dayanıklı cam

Renk : Füme, Metalik Gri, Siyah

Armatürün yüzeyine elektrostatik toz boyadan önce korozyon direncini artırıcı zincrim uygulanır.
LED sürücüsü dahil

Material : Die-cast aluminium and extruded body, tempered glass

Color : Graphite, Metallic Grey, Black

For corrosion resistance, zincrim applied to surface of the luminaire before electrostatic powder coating
With LED driver

534L22

534L53

20W. POWER LED

30W. POWER LED

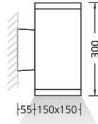

IP 65



538117

530120



MAX.1x35W.-70W. HIT-CE G12



MAX.1x75W. QPAR30 E27



LED Tipi LED Type	Renk Isısı Color Temperature	Toplam Güç Total Power	Akım Current	Voltaj Voltage	Toplam Lümen Total Lumen
Power LED	3000K	2x20W	500mA	220V AC	2x1896lm
Power LED	4000K	2x20W	500mA	220V AC	2x2116lm
Power LED	6500K	2x20W	500mA	220V AC	2x2384lm

LED Tipi LED Type	Renk Isısı Color Temperature	Toplam Güç Total Power	Akım Current	Voltaj Voltage	Toplam Lümen Total Lumen
Power LED	3000K	2x30W	700mA	220V AC	2x2458lm
Power LED	4000K	2x30W	700mA	220V AC	2x2760lm
Power LED	6500K	2x30W	700mA	220V AC	2x3087lm

Malzeme : Alüminyum profil ve enjeksiyon gövde, ısıya dayanıklı cam

Renk : Füme, Metalik Gri, Siyah

Armatürün yüzeyine elektrostatik toz boyadan önce korozyon direncini artırıcı zincrim uygulanır.
LED sürücüsü dahil

Material : Die-cast aluminium and extruded body, tempered glass

Color : Graphite, Metallic Grey, Black

For corrosion resistance, zincrim applied to surface of the luminaire before electrostatic powder coating
With LED driver

534L23

534L54

20W. POWER LED

30W. POWER LED

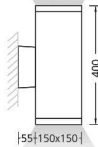

IP 65



538202

530203



MAX.2x35W.-70W. HIT-CE G12



MAX.2x75W. QPAR30 E27



LED Tipi LED Type	Renk Isısı Color Temperature	Toplam Güç Total Power	Akım Current	Voltaj Voltage	Toplam Lümen Total Lumen
Middle Power LED	3000K	11W	116mA	220V AC	953lm
Middle Power LED	4000K	11W	116mA	220V AC	1044lm

Malzeme : Paslanmaz çelik ön kapak ve plastik enjeksiyon gövde, asimetrik alüminyum reflektör ve ısıya dayanıklı cam
Renk : Füme, Metalik Gri, Siyah
 Armatürün yüzeyine elektrostatik toz boyadan önce korozyon direncini artırıcı zincrim uygulanır. LED sürücüsü dahil

Material : Stainless-steel front frame and plastic injection body, asymmetric aluminium reflector and tempered glass
Color : Graphite, Metallic Grey, Black
 For corrosion resistance, zincrim applied to surface of the luminaire before electrostatic powder coating With LED driver

534L30

MIDDLE POWER LED

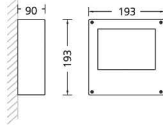

IP 65



538103



MAX.10W. TC-DEL G24d1



LED Tipi LED Type	Renk Isısı Color Temperature	Toplam Güç Total Power	Akım Current	Voltaj Voltage	Toplam Lümen Total Lumen
Middle Power LED	3000K	15W	116mA	220V AC	1427lm
Middle Power LED	4000K	15W	116mA	220V AC	1587lm

Malzeme : Paslanmaz çelik ön kapak ve plastik enjeksiyon gövde, asimetrik alüminyum reflektör ve ısıya dayanıklı cam
Renk : Füme, Metalik Gri, Siyah
 Armatürün yüzeyine elektrostatik toz boyadan önce korozyon direncini artırıcı zincrim uygulanır. LED sürücüsü dahil

Material : Stainless-steel front frame and plastic injection body, asymmetric aluminium reflector and tempered glass
Color : Graphite, Metallic Grey, Black
 For corrosion resistance, zincrim applied to surface of the luminaire before electrostatic powder coating With LED driver

534L31

MIDDLE POWER LED

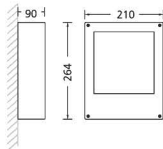

IP 65



538104



MAX.10W. TC-DEL G24d1



LED Tipi LED Type	Renk Isısı Color Temperature	Toplam Güç Total Power	Akım Current	Voltaj Voltage	Toplam Lümen Total Lumen
Middle Power LED	3000K	11W	116mA	220V AC	953lm
Middle Power LED	4000K	11W	116mA	220V AC	1044lm

Malzeme : Alüminyum profil ve enjeksiyon gövde, opal akrilik difüzör

Renk : Füme, Metalik Gri, Beyaz, Siyah

Armatürün yüzeyine elektrostatik toz boyadan önce korozyon direncini artırıcı zincrim uygulanır.
LED sürücüsü dahil

Material : Die-cast aluminium and extruded body, opaline acrylic diffuser

Color : Graphite, Metallic Grey, White, Black

For corrosion resistance, zincrim applied to surface of the luminaire before electrostatic powder coating
With LED driver

534L04

MIDDLE POWER LED

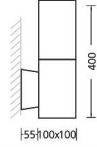

IP 54



530125



MAX.20W. TC-T8E E27

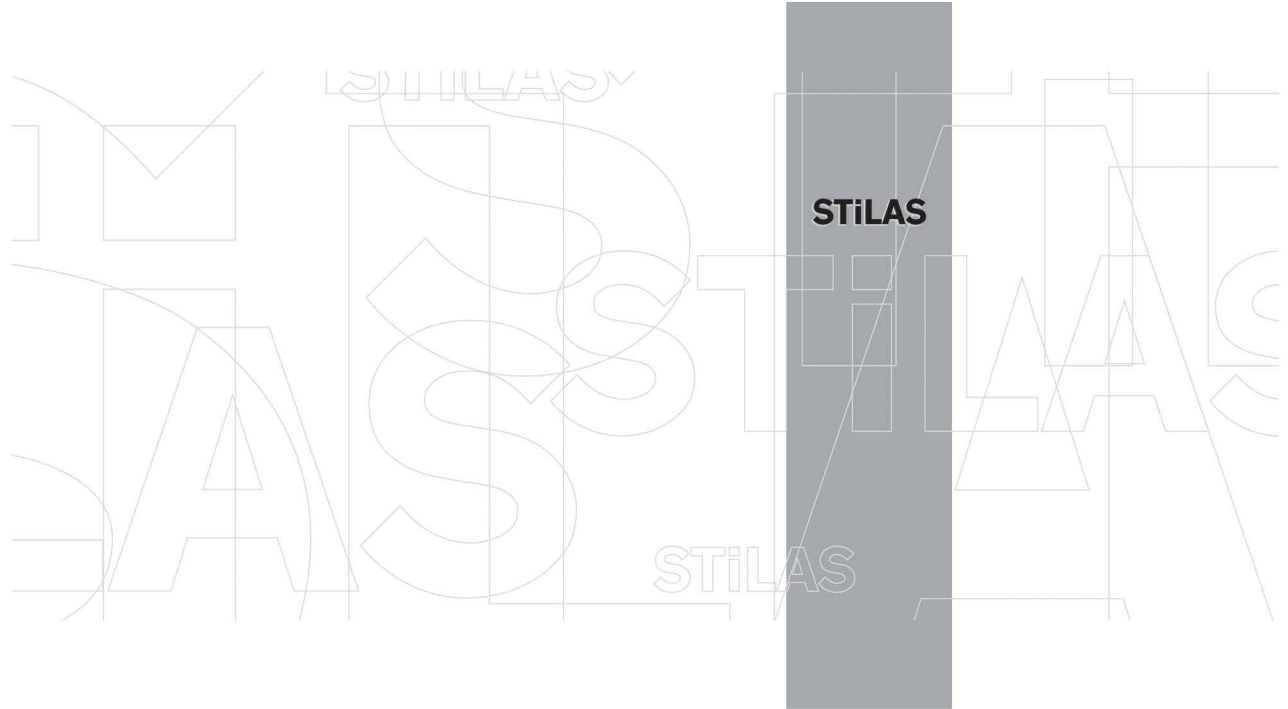

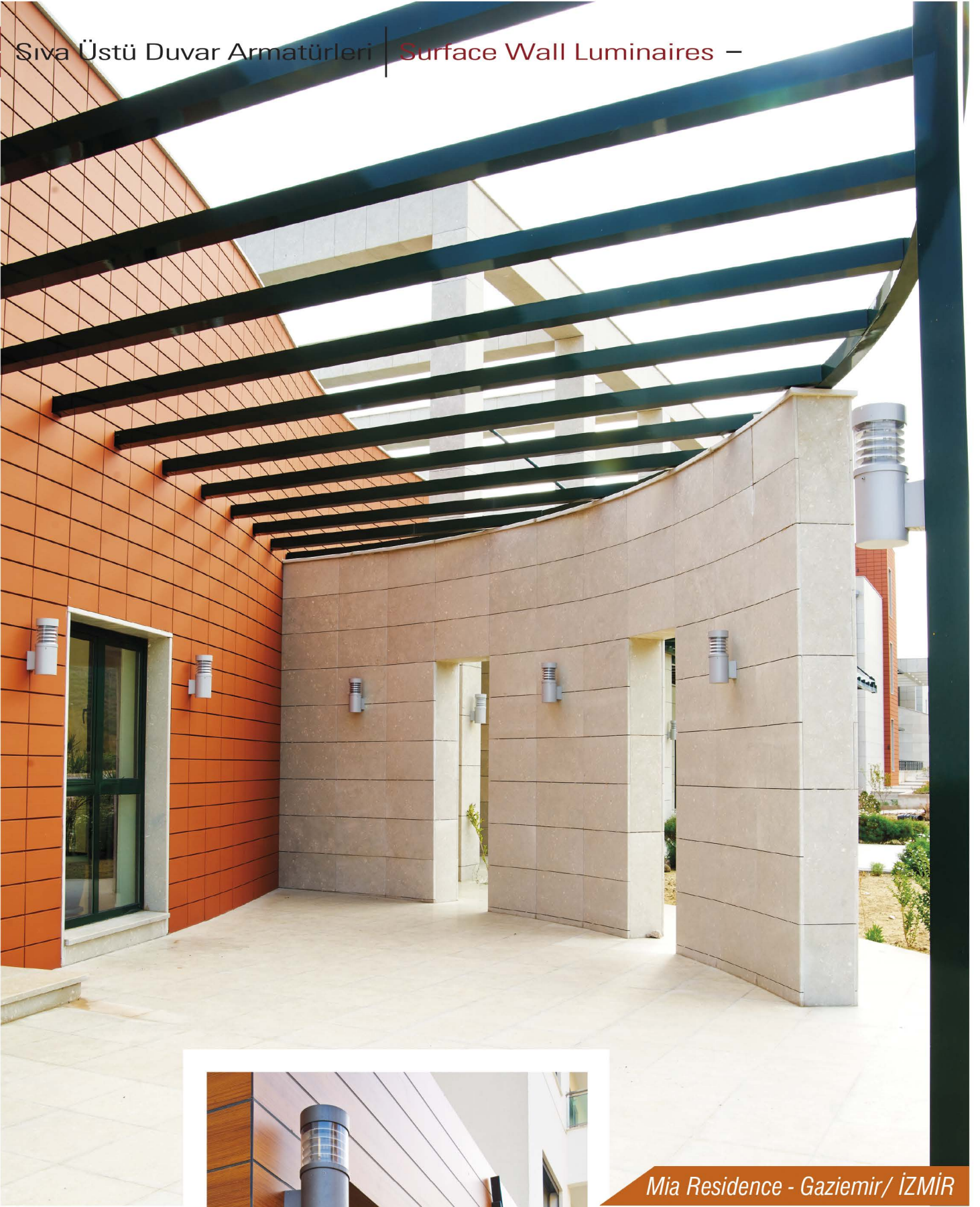

Mia Residence - Gazimir / İZMİR



LED Tipi LED Type	Renk Isısı Color Temperature	Toplam Güç Total Power	Akım Current	Voltaj Voltage	Toplam Lümen Total Lumen
Middle Power LED	3000K	22W	116mA	220V AC	1905lm
Middle Power LED	4000K	22W	116mA	220V AC	2087lm

Malzeme : Alüminyum profil ve enjeksiyon gövde, polikarbonat difüzör
Renk : Füme, Metalik Gri, Siyah
 Armatürün yüzeyine elektrostatik toz boyadan önce korozyon direncini artırıcı zincrim uygulanır.
 LED sürücüsü dahil

Material : Die-cast aluminium and extruded body, polycarbonate diffuser
Color : Graphite, Metallic Grey, Black
 For corrosion resistance, zincrim applied to surface of the luminaire before electrostatic powder coating
 With LED driver

534L33

MIDDLE POWER LED

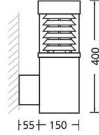

IP 65



538106



MAX.26W. TC-TEL GX24d3

530105



MAX.20W. TC-TSE E27



LED Tipi LED Type	Renk Isısı Color Temperature	Toplam Güç Total Power	Akım Current	Voltaj Voltage	Toplam Lümen Total Lumen
Middle Power LED	3000K	22W	116mA	220V AC	1905lm
Middle Power LED	4000K	22W	116mA	220V AC	2087lm

Malzeme : Alüminyum profil ve enjeksiyon gövde, polikarbonat difüzör
Renk : Füme, Metalik Gri, Siyah
 Armatürün yüzeyine elektrostatik toz boyadan önce korozyon direncini artırıcı zincrim uygulanır.
 LED sürücüsü dahil

Material : Die-cast aluminium and extruded body, polycarbonate diffuser
Color : Graphite, Metallic Grey, Black
 For corrosion resistance, zincrim applied to surface of the luminaire before electrostatic powder coating
 With LED driver

534L34

MIDDLE POWER LED

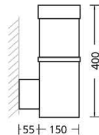

IP 65



538125



MAX.26W. TC-TEL GX24d3

530122



MAX.20W. TC-TSE E27



LED Tipi LED Type	Renk Isısı Color Temperature	Toplam Güç Total Power	Akım Current	Voltaj Voltage	Toplam Lümen Total Lumen
Middle Power LED	3000K	22W	116mA	220V AC	1905lm
Middle Power LED	4000K	22W	116mA	220V AC	2087lm

Malzeme : Alüminyum profil ve enjeksiyon gövde, alüminyum reflektör ve polikarbonat difüzör
Renk : Füme, Metalik Gri, Siyah
 Armatürün yüzeyine elektrostatik toz boyadan önce korozyon direncini arttırıcı zincoprım uygulanır.
 LED sürücüsü dahil

Material : Die-cast aluminium and extruded body, aluminium reflector and polycarbonate diffuser
Color : Graphite, Metallic Grey, Black
 For corrosion resistance, zincoprım applied to surface of the luminaire before electrostatic powder coating
 With LED driver

534L38

MIDDLE POWER LED

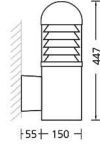

IP 65



538119



MAX.26W. TC-TEL GX24d3

530123



MAX.20W. TC-TSE E27



LED Tipi LED Type	Renk Isısı Color Temperature	Toplam Güç Total Power	Akım Current	Voltaj Voltage	Toplam Lümen Total Lumen
Middle Power LED	3000K	22W	116mA	220V AC	1905lm
Middle Power LED	4000K	22W	116mA	220V AC	2087lm

Malzeme : Alüminyum profil ve enjeksiyon gövde, polikarbonat difüzör
Renk : Füme, Metalik Gri, Siyah
 Armatürün yüzeyine elektrostatik toz boyadan önce korozyon direncini arttırıcı zincoprım uygulanır.
 LED sürücüsü dahil

Material : Die-cast aluminium and extruded body, polycarbonate diffuser
Color : Graphite, Metallic Grey, Black
 For corrosion resistance, zincoprım applied to surface of the luminaire before electrostatic powder coating
 With LED driver

534L39

MIDDLE POWER LED

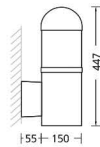

IP 65



538126



MAX.26W. TC-TEL GX24d3

530124



MAX.20W. TC-TSE E27



Malzeme : Alüminyum profil ve enjeksiyon gövde, ısıya dayanıklı cam
 Renk : Füme, Metalik Gri, Siyah
 Armatürün yüzüne elektrostatik toz boyadan önce
 korozyon direncini arttırıcı zincoprim uygulanır
 LED sürücüsü dahil

Material : Die-cast aluminium and extruded body, tempered glass
 Color : Graphite, Metallic Grey, Black
 For corrosion resistance, zincoprim applied to surface
 of the luminaire before electrostatic powder coating
 With LED driver



IP 67



534L05

9 x POWER LED

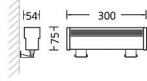

LED Tipi LED Type	Renk Isısı Color Temperature	Toplam Güç Total Power	Akım Current	Voltaj Voltage	Toplam Lümen Total Lumen
Power LED	3000K	10W	350mA	220V AC	1053lm
Power LED	4000K	10W	350mA	220V AC	1134lm
Power LED	6500K	10W	350mA	220V AC	1323lm

534L06

18 x POWER LED

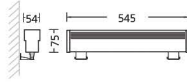

LED Tipi LED Type	Renk Isısı Color Temperature	Toplam Güç Total Power	Akım Current	Voltaj Voltage	Toplam Lümen Total Lumen
Power LED	3000K	21W	350mA	220V AC	2106lm
Power LED	4000K	21W	350mA	220V AC	2268lm
Power LED	6500K	21W	350mA	220V AC	2646lm

534L07

27 x POWER LED

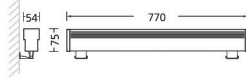

LED Tipi LED Type	Renk Isısı Color Temperature	Toplam Güç Total Power	Akım Current	Voltaj Voltage	Toplam Lümen Total Lumen
Power LED	3000K	32W	350mA	220V AC	3159lm
Power LED	4000K	32W	350mA	220V AC	3402lm
Power LED	6500K	32W	350mA	220V AC	3969lm

534L08

36 x POWER LED

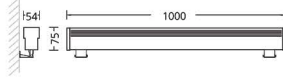

LED Tipi LED Type	Renk Isısı Color Temperature	Toplam Güç Total Power	Akım Current	Voltaj Voltage	Toplam Lümen Total Lumen
Power LED	3000K	42W	350mA	220V AC	4212lm
Power LED	4000K	42W	350mA	220V AC	4536lm
Power LED	6500K	42W	350mA	220V AC	5292lm

538111

MAX.14W. / 24W. T16 G5

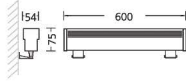

538112

MAX.21W. / 39W. T16 G5

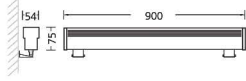

538113

MAX.28W. / 54W. T16 G5

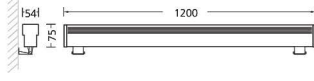

538114

MAX.35W. / 49W. / 80W. T16 G5

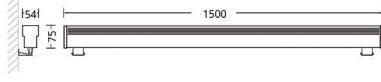

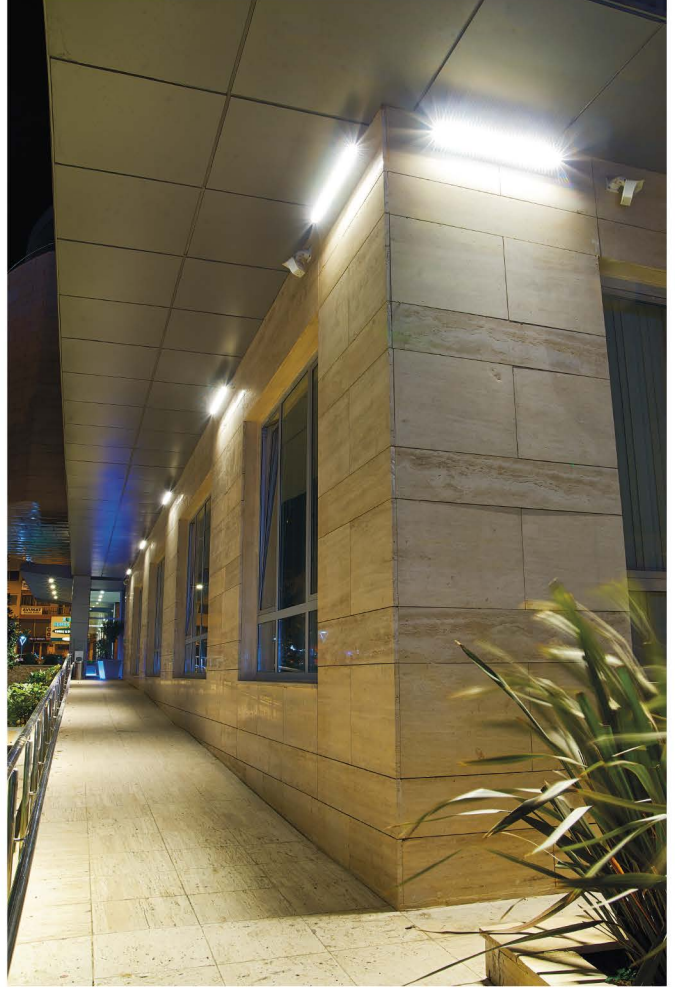

Gazıemir Belediyesi - Gazıemir/ İZMİR



Diş Aydınlatma Armatürleri | external luminaires



LED Tipi LED Type	Renk Isısı Color Temperature	Toplam Güç Total Power	Akım Current	Voltaj Voltage	Toplam Lümen Total Lumen
Middle Power LED	3000K	11W	116mA	220V AC	953lm
Middle Power LED	4000K	11W	116mA	220V AC	1044lm

Malzeme : Alüminyum profil ve enjeksiyon gövde, alüminyum reflektör ve polikarbonat difüzör
Renk : Füme, Metalik Gri, Beyaz, Siyah
 Armatürün yüzeyine elektrostatik toz boyadan önce korozyon direncini arttırıcı zincoprım uygulanır.
 LED sürücüsü dahil

Material : Die-cast aluminium and extruded body, aluminium reflector and polycarbonate diffuser
Color : Graphite, Metallic Grey, White, Black
 For corrosion resistance, zincoprım applied to surface of the luminaire before electrostatic powder coating
 With LED driver

534L40

MIDDLE POWER LED

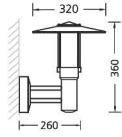

IP 65



530128



MAX.20W. TC-TSE E27



LED Tipi LED Type	Renk Isısı Color Temperature	Toplam Güç Total Power	Akım Current	Voltaj Voltage	Toplam Lümen Total Lumen
Power LED	3000K	54W	700mA	220V AC	4916lm
Power LED	4000K	54W	700mA	220V AC	5520lm
Power LED	6500K	54W	700mA	220V AC	6134lm

Malzeme : Alüminyum gövde ve ısıya dayanıklı cam
Renk : Füme, Metalik Gri, Beyaz, Siyah
 Armatürün yüzeyine elektrostatik toz boyadan önce korozyon direncini arttırıcı zincoprım uygulanır.
 LED sürücüsü dahil

Material : Die-cast aluminium body and tempered glass
Color : Graphite, Metallic Grey, White, Black
 For corrosion resistance, zincoprım applied to surface of the luminaire before electrostatic powder coating
 With LED driver

534L41

POWER LED

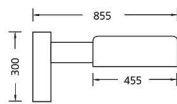

IP 65



538127



MAX.35W-70W. HIT-CE G12



Malzeme : Alüminyum profil ve enjeksiyon gövde, akrilik difüzör
 Renk : Füme, Metalik Gri, Siyah
 Armatürün yüzeyine elektrostatik toz boyadan önce korozyon direncini arttırıcı zincoprim uygulanır
 LED sürücüsü dahil

Material : Die-cast aluminium and extruded body, acrylic diffuser
 Color : Graphite, Metallic Grey, Black
 For corrosion resistance, zincoprim applied to surface of the luminaire before electrostatic powder coating
 With LED driver

LED Tipi LED Type	Renk Isısı Color Temperature	Toplam Güç Total Power	Akım Current	Voltaj Voltage	Toplam Lümen Total Lumen
Power LED	3000K	54W	700mA	220V AC	4916lm
Power LED	4000K	54W	700mA	220V AC	5520lm
Power LED	6500K	54W	700mA	220V AC	6134lm

534L35

538120

POWER LED

MAX.1x55W. TC-L 2G11

IP 65



Malzeme : Alüminyum profil ve enjeksiyon gövde, akrilik difüzör
 Renk : Füme, Metalik Gri, Siyah
 Armatürün yüzeyine elektrostatik toz boyadan önce korozyon direncini arttırıcı zincoprim uygulanır
 LED sürücüsü dahil

Material : Die-cast aluminium and extruded body, acrylic diffuser
 Color : Graphite, Metallic Grey, Black
 For corrosion resistance, zincoprim applied to surface of the luminaire before electrostatic powder coating
 With LED driver

LED Tipi LED Type	Renk Isısı Color Temperature	Toplam Güç Total Power	Akım Current	Voltaj Voltage	Toplam Lümen Total Lumen
Power LED	3000K	82W	700mA	220V AC	7374lm
Power LED	4000K	82W	700mA	220V AC	8280lm
Power LED	6500K	82W	700mA	220V AC	9261lm

534L36

538121

POWER LED

MAX.1x80W. TC-L 2G11

IP 65



Malzeme : Alüminyum profil ve enjeksiyon gövde, paslanmaz çelik yansıtıcı, alüminyum iç reflektör ve ısıya dayanıklı cam
 Renk : Füme, Metalik Gri, Siyah
 Armatürün yüzüne elektrostatik toz boyadan önce korozyon direncini arttırıcı zincoprım uygulanır
 LED sürücüsü dahil

Material : Die-cast aluminium and extruded body, stainless-steel reflector, aluminium inner reflector and tempered glass
 Color : Graphite, Metallic Grey, Black
 For corrosion resistance, zincoprım applied to surface of the luminaire before electrostatic powder coating
 With LED driver

LED Tipi LED Type	Renk Isısı Color Temperature	Toplam Güç Total Power	Akım Current	Voltaj Voltage	Toplam Lümen Total Lumen
Power LED	3000K	45W	700mA	220V AC	3687lm
Power LED	4000K	45W	700mA	220V AC	4140lm
Power LED	6500K	45W	700mA	220V AC	4630lm

534L42

POWER LED

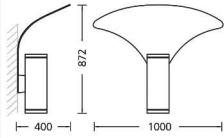

IP 65



538105



MAX.35W.-70W. HIT-CE G12

STILAS

STILAS



LED Tipi LED Type	Renk Isısı Color Temperature	Toplam Güç Total Power	Akım Current	Voltaj Voltage	Toplam Lümen Total Lumen
Middle Power LED	3000K	44W	116mA	220V AC	3810lm
Middle Power LED	4000K	44W	116mA	220V AC	4174lm

Malzeme : Üst baslık alüminyum enjeksiyon ve polikarbonat difüzör, alüminyum reflektör
Renk : Füme, Metalik Gri, Siyah
Armatürün yüzeyine elektrostatik toz boyadan önce korozyon direncini artırıcı zincrim uygulanır.
LED sürücüsü dahil

Material : Die-cast aluminium and polycarbonate diffuser upper head aluminium reflector
Color : Graphite, Metallic Grey, Black
For corrosion resistance, zincrim applied to surface of the luminaire before electrostatic powder coating
With LED driver

534L43

MIDDLE POWER LED

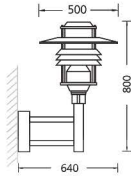

IP 65



538205



MAX.2X24W, TC-L 2G11

STILAS



LED Tipi LED Type	Renk Isısı Color Temperature	Toplam Güç Total Power	Akım Current	Voltaj Voltage	Toplam Lümen Total Lumen
Middle Power LED	3000K	44W	116mA	220V AC	3810lm
Middle Power LED	4000K	44W	116mA	220V AC	4174lm

Malzeme : Üst baslık alüminyum enjeksiyon ve polikarbonat difüzör, alüminyum iç reflektör

Renk : Füme, Metalik Gri, Siyah

Armatürün yüzeyine elektrostatik toz boyadan önce korozyon direncini artırıcı zincrim uygulanır.
LED sürücüsü dahil

Material : Die-cast aluminium and polycarbonate diffuser upper head aluminium inner reflector

Color : Graphite, Metallic Grey, Black

For corrosion resistance, zincrim applied to surface of the luminaire before electrostatic powder coating
With LED driver

534L44

MIDDLE POWER LED

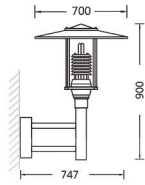

IP 65



538206



MAX.2X24W. TC-L 2G11



LED Tipi LED Type	Renk Isısı Color Temperature	Toplam Güç Total Power	Akım Current	Voltaj Voltage	Toplam Lümen Total Lumen
Middle Power LED	3000K	44W	116mA	220V AC	3810lm
Middle Power LED	4000K	44W	116mA	220V AC	4174lm

Malzeme : Üst baslık alüminyum enjeksiyon ve polikarbonat difüzör, alüminyum iç reflektör
Renk : Füme, Metalik Gri, Siyah
Armatürün yüzeyine elektrostatik toz boyadan önce korozyon direncini arttırıcı zincrim uygulanır.
LED sürücüsü dahil

Material : Die-cast aluminium and polycarbonate diffuser upper head aluminium inner reflector
Color : Graphite, Metallic Grey, Black
For corrosion resistance, zincrim applied to surface of the luminaire before electrostatic powder coating
With LED driver

534L45

MIDDLE POWER LED

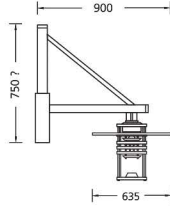

IP 65



CE

538128



MAX.70W. HSE E27

STILAS



STILAS

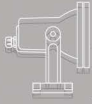

Exterior Luminaires

Dış Aydınlatma Armatürleri

Projektörler

Projectors



LED Tipi LED Type	Renk Isısı Color Temperature	Toplam Güç Total Power	Akım Current	Voltaj Voltage	Toplam Lümen Total Lumen
Power LED	3000K	5W	500mA	220V AC	474lm
Power LED	4000K	5W	500mA	220V AC	529lm
Power LED	6500K	5W	500mA	220V AC	596lm

Malzeme : Alüminyum enjeksiyon gövde ve ısıya dayanıklı cam

Renk : Füme, Metalik Gri, Siyah

Armatürün yüzeyine elektrostatik toz boyadan önce korozyon direncini arttırıcı zincrim uygulanır.
LED sürücüsü dahil

Material : Die-cast aluminium body and tempered glass

Color : Graphite, Metallic Grey, Black

For corrosion resistance, zincrim applied to surface of the luminaire before electrostatic powder coating
With LED driver

544L03

POWER LED

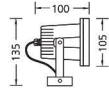

IP 65



541103



MAX.50W, QPAR16 GU10



LED Tipi LED Type	Renk Isısı Color Temperature	Toplam Güç Total Power	Akım Current	Voltaj Voltage	Toplam Lümen Total Lumen
Power LED	3000K	5W	500mA	220V AC	474lm
Power LED	4000K	5W	500mA	220V AC	529lm
Power LED	6500K	5W	500mA	220V AC	596lm

Malzeme : Alüminyum enjeksiyon gövde ve ısıya dayanıklı cam

Renk : Füme, Metalik Gri, Siyah

Armatürün yüzeyine elektrostatik toz boyadan önce korozyon direncini arttırıcı zincrim uygulanır.
LED sürücüsü dahil

Material : Die-cast aluminium body and tempered glass

Color : Graphite, Metallic Grey, Black

For corrosion resistance, zincrim applied to surface of the luminaire before electrostatic powder coating
With LED driver

544L04

POWER LED

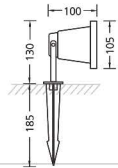

IP 65



541104



MAX.50W, QPAR16 GU10





LED Tipi LED Type	Renk Isısı Color Temperature	Toplam Güç Total Power	Akım Current	Voltaj Voltage	Toplam Lümen Total Lumen
Power LED	3000K	15W	500mA	220V AC	1422lm
Power LED	4000K	15W	500mA	220V AC	1587lm
Power LED	6500K	15W	500mA	220V AC	1788lm

Malzeme : Alüminyum enjeksiyon gövde ve ısıya dayanıklı cam

Renk : Füme, Metalik Gri, Siyah

Armatürün yüzeyine elektrostatik toz boyadan önce korozyon direncini artırıcı zincrim uygulanır.
LED sürücüsü dahil

Material : Die-cast aluminium body and tempered glass

Color : Graphite, Metallic Grey, Black

For corrosion resistance, zincrim applied to surface of the luminaire before electrostatic powder coating
With LED driver

544L01

POWER LED

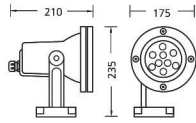

IP 65



541101



MAX.75W. QPAR30 E27



LED Tipi LED Type	Renk Isısı Color Temperature	Toplam Güç Total Power	Akım Current	Voltaj Voltage	Toplam Lümen Total Lumen
Power LED	3000K	15W	500mA	220V AC	1422lm
Power LED	4000K	15W	500mA	220V AC	1587lm
Power LED	6500K	15W	500mA	220V AC	1788lm

Malzeme : Alüminyum enjeksiyon gövde ve ısıya dayanıklı cam

Renk : Füme, Metalik Gri, Siyah

Armatürün yüzeyine elektrostatik toz boyadan önce korozyon direncini artırıcı zincrim uygulanır.
LED sürücüsü dahil

Material : Die-cast aluminium body and tempered glass

Color : Graphite, Metallic Grey, Black

For corrosion resistance, zincrim applied to surface of the luminaire before electrostatic powder coating
With LED driver

544L02

POWER LED

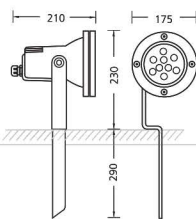

IP 65



541102



MAX.75W. QPAR30 E27



Dış Aydınlatma Armatürleri | Exterior Luminaires



Teras Villaları - Bodrum/MUĞLA



LED Tipi LED Type	Renk Isısı Color Temperature	Toplam Güç Total Power	Akım Current	Voltaj Voltage	Toplam Lümen Total Lumen
Power LED	3000K	5W	500mA	220V AC	474lm
Power LED	4000K	5W	500mA	220V AC	529lm
Power LED	6500K	5W	500mA	220V AC	596lm

Malzeme : Alüminyum enjeksiyon gövde ve ısıya dayanıklı cam

Renk : Füme, Metalik Gri, Siyah

Armatürün yüzeyine elektrostatik toz boyadan önce korozyon direncini arttırıcı zincrim uygulanır.
LED sürücüsü dahil

Material : Die-cast aluminium body and tempered glass

Color : Graphite, Metallic Grey, Black

For corrosion resistance, zincrim applied to surface of the luminaire before electrostatic powder coating
With LED driver

544L12

POWER LED

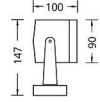

IP 65



LED Tipi LED Type	Renk Isısı Color Temperature	Toplam Güç Total Power	Akım Current	Voltaj Voltage	Toplam Lümen Total Lumen
Power LED	3000K	5W	500mA	220V AC	474lm
Power LED	4000K	5W	500mA	220V AC	529lm
Power LED	6500K	5W	500mA	220V AC	596lm

Malzeme : Alüminyum enjeksiyon gövde ve ısıya dayanıklı cam

Renk : Füme, Metalik Gri, Siyah

Armatürün yüzeyine elektrostatik toz boyadan önce korozyon direncini arttırıcı zincrim uygulanır.
LED sürücüsü dahil

Material : Die-cast aluminium body and tempered glass

Color : Graphite, Metallic Grey, Black

For corrosion resistance, zincrim applied to surface of the luminaire before electrostatic powder coating
With LED driver

544L09

POWER LED

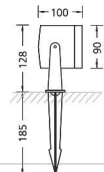

IP 65





LED Tipi LED Type	Renk Isısı Color Temperature	Toplam Güç Total Power	Akım Current	Voltaj Voltage	Toplam Lümen Total Lumen
Power LED	3000K	10W	500mA	220V AC	948lm
Power LED	4000K	10W	500mA	220V AC	1058lm
Power LED	6500K	10W	500mA	220V AC	1192lm

Malzeme : Alüminyum enjeksiyon gövde ve ısıya dayanıklı cam

Renk : Füme, Metalik Gri, Siyah

Armatürün yüzeyine elektrostatik toz boyadan önce korozyon direncini artırıcı zincrim uygulanır.
LED sürücüsü dahil

Material : Die-cast aluminium body and tempered glass

Color : Graphite, Metallic Grey, Black

For corrosion resistance, zincrim applied to surface of the luminaire before electrostatic powder coating
With LED driver

544L13

POWER LED

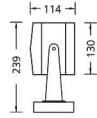

IP 65



LED Tipi LED Type	Renk Isısı Color Temperature	Toplam Güç Total Power	Akım Current	Voltaj Voltage	Toplam Lümen Total Lumen
Power LED	3000K	10W	500mA	220V AC	948lm
Power LED	4000K	10W	500mA	220V AC	1058lm
Power LED	6500K	10W	500mA	220V AC	1192lm

Malzeme : Alüminyum enjeksiyon gövde ve ısıya dayanıklı cam

Renk : Füme, Metalik Gri, Siyah

Armatürün yüzeyine elektrostatik toz boyadan önce korozyon direncini artırıcı zincrim uygulanır.
LED sürücüsü dahil

Material : Die-cast aluminium body and tempered glass

Color : Graphite, Metallic Grey, Black

For corrosion resistance, zincrim applied to surface of the luminaire before electrostatic powder coating
With LED driver

544L10

POWER LED

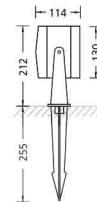

IP 65





LED Tipi LED Type	Renk Isısı Color Temperature	Toplam Güç Total Power	Akım Current	Voltaj Voltage	Toplam Lümen Total Lumen
Power LED	3000K	20W	700mA	220V AC	1896lm
Power LED	4000K	20W	700mA	220V AC	2116lm
Power LED	6500K	20W	700mA	220V AC	2384lm

Malzeme : Alüminyum enjeksiyon gövde ve ısıya dayanıklı cam

Renk : Füme, Metalik Gri, Siyah

Armatürün yüzeyine elektrostatik toz boyadan önce korozyon direncini arttırıcı zincrim uygulanır.
LED sürücüsü dahil

Material : Die-cast aluminium body and tempered glass

Color : Graphite, Metallic Grey, Black

For corrosion resistance, zincprim applied to surface of the luminaire before electrostatic powder coating
With LED driver

544L14

POWER LED

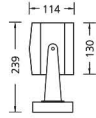

IP 65



LED Tipi LED Type	Renk Isısı Color Temperature	Toplam Güç Total Power	Akım Current	Voltaj Voltage	Toplam Lümen Total Lumen
Power LED	3000K	20W	700mA	220V AC	1896lm
Power LED	4000K	20W	700mA	220V AC	2116lm
Power LED	6500K	20W	700mA	220V AC	2384lm

Malzeme : Alüminyum enjeksiyon gövde ve ısıya dayanıklı cam

Renk : Füme, Metalik Gri, Siyah

Armatürün yüzeyine elektrostatik toz boyadan önce korozyon direncini arttırıcı zincrim uygulanır.
LED sürücüsü dahil

Material : Die-cast aluminium body and tempered glass

Color : Graphite, Metallic Grey, Black

For corrosion resistance, zincprim applied to surface of the luminaire before electrostatic powder coating
With LED driver

544L11

POWER LED

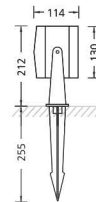

IP 65





LED Tipi LED Type	Renk Isısı Color Temperature	Toplam Güç Total Power	Akım Current	Voltaj Voltage	Toplam Lümen Total Lumen
COB LED	3000K	8W	300mA	220V AC	669lm
COB LED	4000K	8W	300mA	220V AC	700lm

Malzeme : Alüminyum enjeksiyon gövde ve ısıya dayanıklı cam

Renk : Füme, Metalik Gri, Siyah

Armatürün yüzeyine elektrostatik toz boyadan önce korozyon direncini arttırıcı zincrim uygulanır.
LED sürücüsü dahil

Material : Die-cast aluminium body and tempered glass

Color : Graphite, Metallic Grey, Black

For corrosion resistance, zincrim applied to surface of the luminaire before electrostatic powder coating
With LED driver

544L29

COB LED



IP 65



LED Tipi LED Type	Renk Isısı Color Temperature	Toplam Güç Total Power	Akım Current	Voltaj Voltage	Toplam Lümen Total Lumen
COB LED	3000K	8W	300mA	220V AC	669lm
COB LED	4000K	8W	300mA	220V AC	700lm

Malzeme : Alüminyum enjeksiyon gövde ve ısıya dayanıklı cam

Renk : Füme, Metalik Gri, Siyah

Armatürün yüzeyine elektrostatik toz boyadan önce korozyon direncini arttırıcı zincrim uygulanır.
LED sürücüsü dahil

Material : Die-cast aluminium body and tempered glass

Color : Graphite, Metallic Grey, Black

For corrosion resistance, zincrim applied to surface of the luminaire before electrostatic powder coating
With LED driver

544L30

COB LED

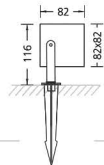

IP 65





LED Tipi LED Type	Renk Isısı Color Temperature	Toplam Güç Total Power	Akım Current	Voltaj Voltage	Toplam Lümen Total Lumen
Power LED	3000K	10W	500mA	220V AC	948lm
Power LED	4000K	10W	500mA	220V AC	1058lm
Power LED	6500K	10W	500mA	220V AC	1192lm

Malzeme : Alüminyum enjeksiyon gövde ve ısıya dayanıklı cam

Renk : Füme, Metalik Gri, Siyah

Armatürün yüzeyine elektrostatik toz boyadan önce korozyon direncini arttırıcı zincrim uygulanır.
LED sürücüsü dahil

Material : Die-cast aluminium body and tempered glass

Color : Graphite, Metallic Grey, Black

For corrosion resistance, zincrim applied to surface of the luminaire before electrostatic powder coating
With LED driver

544L05

POWER LED

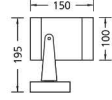

IP 65



LED Tipi LED Type	Renk Isısı Color Temperature	Toplam Güç Total Power	Akım Current	Voltaj Voltage	Toplam Lümen Total Lumen
Power LED	3000K	20W	700mA	220V AC	1896lm
Power LED	4000K	20W	700mA	220V AC	2116lm
Power LED	6500K	20W	700mA	220V AC	2384lm

Malzeme : Alüminyum enjeksiyon gövde ve ısıya dayanıklı cam

Renk : Füme, Metalik Gri, Siyah

Armatürün yüzeyine elektrostatik toz boyadan önce korozyon direncini arttırıcı zincrim uygulanır.
LED sürücüsü dahil

Material : Die-cast aluminium body and tempered glass

Color : Graphite, Metallic Grey, Black

For corrosion resistance, zincrim applied to surface of the luminaire before electrostatic powder coating
With LED driver

544L06

POWER LED

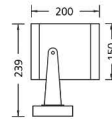

IP 65



548102



35W-70W. HIH-CE G12



LED Tipi LED Type	Renk Isısı Color Temperature	Toplam Güç Total Power	Akım Current	Voltaj Voltage	Toplam Lümen Total Lumen
Power LED	3000K	45W	700mA	220V AC	3687lm
Power LED	4000K	45W	700mA	220V AC	4140lm
Power LED	6500K	45W	700mA	220V AC	4630lm

Malzeme : Alüminyum enjeksiyon gövde ve ısıya dayanıklı cam

Renk : Füme, Metalik Gri, Siyah

Armatürün yüzeyine elektrostatik toz boyadan önce korozyon direncini artırıcı zincrim uygulanır.
LED sürücüsü dahil

Material : Die-cast aluminium body and tempered glass

Color : Graphite, Metallic Grey, Black

For corrosion resistance, zincrim applied to surface of the luminaire before electrostatic powder coating
With LED driver

544L15

POWER LED

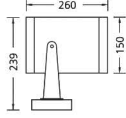

IP 65



548103



35W-70W. HIT-CE G12



LED Tipi LED Type	Renk Isısı Color Temperature	Toplam Güç Total Power	Voltaj Voltage	Toplam Lümen Total Lumen
LED Ampul / Bulb	3000K	23W	220V AC	2322lm
LED Ampul / Bulb	6000K	23W	220V AC	3510lm

Malzeme : Bronz gövde

Renk : Bronz

Armatürün yüzeyine elektrostatik toz boyadan önce korozyon direncini artırıcı zincrim uygulanır.
12V trafo ile kullanılmalı

Material : Sand-cast bronze body

Color : Bronze

For corrosion resistance, zincrim applied to surface of the luminaire before electrostatic powder coating
12V transformer required

542L01



LED AMPUL / BULB 23W. PAR56

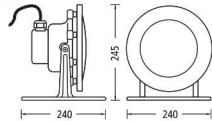

IP 68



542101



MAX.12V. 300W. QPAR56



STILAS

Exterior Luminaires

Dış Aydınlatma Armatürleri

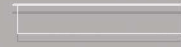
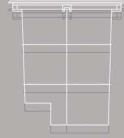
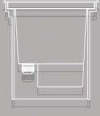

Gömme Yer Armatürleri In-Ground Luminaires

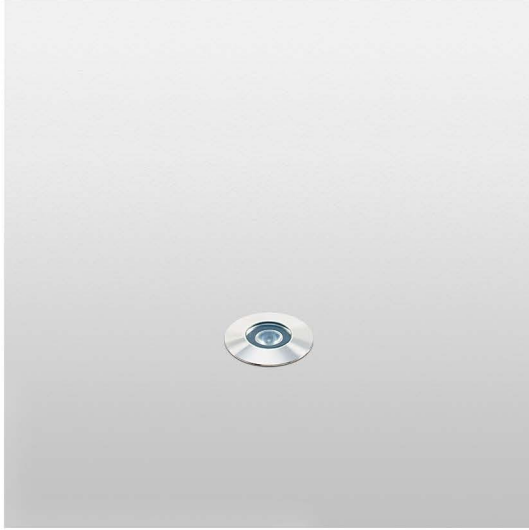

LED Tipi LED Type	Renk Isısı Color Temperature	Toplam Güç Total Power	Akım Current	Voltaj Voltage	Toplam Lümen Total Lumen
Power LED	3000K	1.5W	350mA	220V AC	175lm
Power LED	4000K	1.5W	350mA	220V AC	204lm
Power LED	6500K	1.5W	350mA	220V AC	220lm

Malzeme : Alüminyum profil gövde, paslanmaz çelik ön kapak, ısıya dayanıklı cam ve ankastre montaj kasası

Renk : Mat Çelik
Armatürün yüzeyine elektrostatik toz boyadan önce korozyon direncini arttırıcı zincoprım uygulanır. LED sürücüsü dahil

Material : Extruded aluminium body, stainless-steel front frame, tempered glass and aluminium recessed box

Color : Matt Steel
For corrosion resistance, zincoprım applied to surface of the luminaire before electrostatic powder coating With LED driver

514L29

POWER LED



9MNK15

Ankastre Montaj Kasası / Recessed Box



IP 67



LED Tipi LED Type	Renk Isısı Color Temperature	Toplam Güç Total Power	Akım Current	Voltaj Voltage	Toplam Lümen Total Lumen
Power LED	3000K	3W	700mA	220V AC	351lm
Power LED	4000K	3W	700mA	220V AC	408lm
Power LED	6500K	3W	700mA	220V AC	441lm

Malzeme : Alüminyum profil gövde, paslanmaz çelik ön kapak, ısıya dayanıklı cam ve ankastre montaj kasası

Renk : Mat Çelik
Armatürün yüzeyine elektrostatik toz boyadan önce korozyon direncini arttırıcı zincoprım uygulanır. LED sürücüsü dahil

Material : Extruded aluminium body, stainless-steel front frame, tempered glass and aluminium recessed box

Color : Matt Steel
For corrosion resistance, zincoprım applied to surface of the luminaire before electrostatic powder coating With LED driver

514L28

POWER LED



9MNK36

Ankastre Montaj Kasası / Recessed Box



IP 67





LED Tipi LED Type	Renk Isısı Color Temperature	Toplam Güç Total Power	Akım Current	Voltaj Voltage	Toplam Lümen Total Lumen
Power LED	3000K	5W	500mA	220V AC	474lm
Power LED	4000K	5W	500mA	220V AC	529lm
Power LED	6500K	5W	500mA	220V AC	596lm

Malzeme : Alüminyum enjeksiyon gövde, ısıya ve basınca dayanıklı 8 mm. cam ve termoplastik ankastre montaj kasası
Renk : Füme, Metalik Gri, Siyah
Armatürün yüzeyine elektrostatik toz boyadan önce korozyon direncini arttırıcı zincrim uygulanır. LED sürücüsü dahil
Material : Die-cast aluminium body, toughened glass with 8 mm. and thermoplastic recessed box
Color : Graphite, Metallic Grey, Black
For corrosion resistance, zincrim applied to surface of the luminaire before electrostatic powder coating With LED driver

514L05

POWER LED

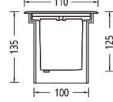

9MNK17

Ankastre Montaj Kasası / Recessed Box



IP 67



510101



MAX.35W. QPAR16 GU10

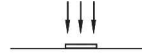

Sabit Yük Dayanımı : 1000 kg
Static Load Resistance : 1000 kg



LED Tipi LED Type	Renk Isısı Color Temperature	Toplam Güç Total Power	Akım Current	Voltaj Voltage	Toplam Lümen Total Lumen
Power LED	3000K	5W	500mA	220V AC	474lm
Power LED	4000K	5W	500mA	220V AC	529lm
Power LED	6500K	5W	500mA	220V AC	596lm

Malzeme : Alüminyum enjeksiyon gövde, ısıya ve basınca dayanıklı 8 mm. cam ve termoplastik ankastre montaj kasası
Renk : Füme, Metalik Gri, Siyah
Armatürün yüzeyine elektrostatik toz boyadan önce korozyon direncini arttırıcı zincrim uygulanır. LED sürücüsü dahil
Material : Die-cast aluminium body, toughened glass with 8 mm. and thermoplastic recessed box
Color : Graphite, Metallic Grey, Black
For corrosion resistance, zincrim applied to surface of the luminaire before electrostatic powder coating With LED driver

514L06

POWER LED

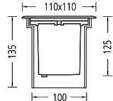

9MNK18

Ankastre Montaj Kasası / Recessed Box



IP 67



510102



MAX.35W. QPAR16 GU10



Sabit Yük Dayanımı : 1000 kg
Static Load Resistance : 1000 kg



LED Tipi LED Type	Renk Isısı Color Temperature	Toplam Güç Total Power	Akım Current	Voltaj Voltage	Toplam Lümen Total Lumen
Power LED	3000K	5W	500mA	220V AC	474lm
Power LED	4000K	5W	500mA	220V AC	529lm
Power LED	6500K	5W	500mA	220V AC	596lm

Malzeme : Alüminyum enjeksiyon gövde ve paslanmaz çelik ön kapak, ısıya ve basınca dayanıklı 8 mm. cam ve termoplastik ankastre montaj kasası

Renk : Mat Çelik
Armatürün yüzeyine elektrostatik toz boyadan önce korozyon direncini arttırıcı zincrim uygulanır. LED sürücüsü dahil

Material : Die-cast aluminium body and stainless-steel front frame, toughened glass with 8 mm. and thermoplastic recessed box

Color : Matt Steel
For corrosion resistance, zincrim applied to surface of the luminaire before electrostatic powder coating With LED driver

514L07

POWER LED

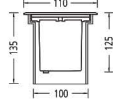

9MNK17

Ankastre Montaj Kasası / Recessed Box



IP 67



510103



MAX.35W. QPAR16 GU10



Sabit Yük Dayanımı : 1000 kg
Static Load Resistance : 1000 kg

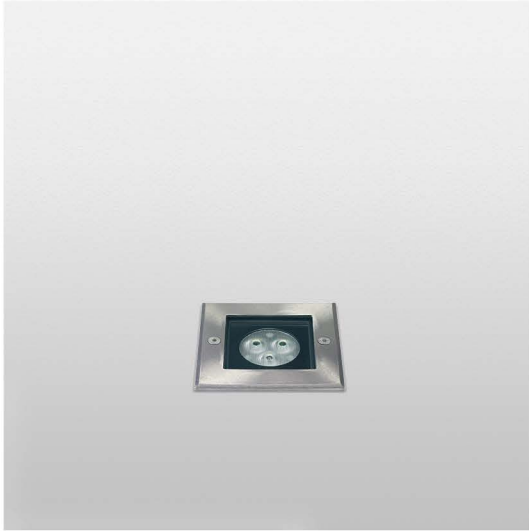

LED Tipi LED Type	Renk Isısı Color Temperature	Toplam Güç Total Power	Akım Current	Voltaj Voltage	Toplam Lümen Total Lumen
Power LED	3000K	5W	500mA	220V AC	474lm
Power LED	4000K	5W	500mA	220V AC	529lm
Power LED	6500K	5W	500mA	220V AC	596lm

Malzeme : Alüminyum enjeksiyon gövde, ısıya ve basınca dayanıklı 8 mm. cam ve termoplastik ankastre montaj kasası

Renk : Mat Çelik
Armatürün yüzeyine elektrostatik toz boyadan önce korozyon direncini arttırıcı zincrim uygulanır. LED sürücüsü dahil

Material : Die-cast aluminium body, toughened glass with 8 mm. and thermoplastic recessed box

Color : Matt Steel
For corrosion resistance, zincrim applied to surface of the luminaire before electrostatic powder coating With LED driver

514L08

POWER LED

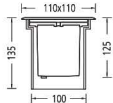

9MNK18

Ankastre Montaj Kasası / Recessed Box



IP 67



510104



MAX.35W. QPAR16 GU10



Sabit Yük Dayanımı : 1000 kg
Static Load Resistance : 1000 kg





LED Tipi LED Type	Renk Isısı Color Temperature	Toplam Güç Total Power	Akım Current	Voltaj Voltage	Toplam Lümen Total Lumen
Power LED	3000K	5W	500mA	220V AC	474lm
Power LED	4000K	5W	500mA	220V AC	529lm
Power LED	6500K	5W	500mA	220V AC	596lm

Malzeme : Alüminyum enjeksiyon gövde, ısıya ve basınca dayanıklı 8 mm. cam ve termoplastik ankastre montaj kasası

Renk : Mat Çelik
Armatürün yüzeyine elektrostatik toz boyadan önce korozyon direncini arttırıcı zincrim uygulanır. LED sürücüsü dahil

Material : Die-cast aluminium body, toughened glass with 8 mm. and thermoplastic recessed box

Color : Matt Steel
For corrosion resistance, zincrim applied to surface of the luminaire before electrostatic powder coating With LED driver

514L09

POWER LED

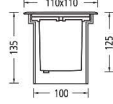

9MNK17

Ankastre Montaj Kasası / Recessed Box



IP 67



510105



MAX.35W. QPAR16 GU10



Sabit Yük Dayanımı : 1000 kg
Static Load Resistance : 1000 kg



LED Tipi LED Type	Renk Isısı Color Temperature	Toplam Güç Total Power	Akım Current	Voltaj Voltage	Toplam Lümen Total Lumen
Power LED	3000K	10W	500mA	220V AC	948lm
Power LED	4000K	10W	500mA	220V AC	1058lm
Power LED	6500K	10W	500mA	220V AC	1192lm

Malzeme : Alüminyum enjeksiyon gövde, ısıya ve basınca dayanıklı 15 mm. cam ve termoplastik ankastre montaj kasası

Renk : Füme, Metalik Gri, Siyah
Armatürün yüzeyine elektrostatik toz boyadan önce korozyon direncini arttırıcı zincrim uygulanır. LED sürücüsü dahil

Material : Die-cast aluminium body, toughened glass with 15 mm. and thermoplastic recessed box

Color : Graphite, Metallic Grey, Black
For corrosion resistance, zincrim applied to surface of the luminaire before electrostatic powder coating With LED driver

514L10

POWER LED

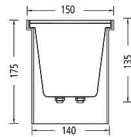

9MNK19

Ankastre Montaj Kasası / Recessed Box



IP 67



Hareketli Yük Dayanımı : 2000 kg - 20 km/h
Moving Load Resistance : 2000 kg - 20 km/h



LED Tipi LED Type	Renk Isısı Color Temperature	Toplam Güç Total Power	Akım Current	Voltaj Voltage	Toplam Lümen Total Lumen
Power LED	3000K	10W	500mA	220V AC	948lm
Power LED	4000K	10W	500mA	220V AC	1058lm
Power LED	6500K	10W	500mA	220V AC	1192lm

Malzeme : Alüminyum enjeksiyon gövde, ısıya ve basınca dayanıklı 15 mm. cam ve termoplastik ankastré montaj kasası

Renk : Füme, Metalik Gri, Siyah
Armatürün yüzeyine elektrostatik toz boyadan önce korozyon direncini artırıcı zincrim uygulanır. LED sürücüsü dahil

Material : Die-cast aluminium body, toughened glass with 15 mm. and thermoplastic recessed box

Color : Graphite, Metallic Grey, Black
For corrosion resistance, zincrim applied to surface of the luminaire before electrostatic powder coating With LED driver

514L20

POWER LED

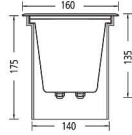

9MNK19

Ankastré Montaj Kasası / Recessed Box



IP 67



Hareketli Yük Dayanımı : 2000 kg - 20 km/h
Moving Load Resistance : 2000 kg - 20 km/h



LED Tipi LED Type	Renk Isısı Color Temperature	Toplam Güç Total Power	Akım Current	Voltaj Voltage	Toplam Lümen Total Lumen
Power LED	3000K	15W	500mA	220V AC	1422lm
Power LED	4000K	15W	500mA	220V AC	1587lm
Power LED	6500K	15W	500mA	220V AC	1788lm

Malzeme : Alüminyum enjeksiyon gövde, ısıya ve basınca dayanıklı 15 mm. cam ve termoplastik ankastré montaj kasası

Renk : Füme, Metalik Gri, Siyah
Armatürün yüzeyine elektrostatik toz boyadan önce korozyon direncini artırıcı zincrim uygulanır. LED sürücüsü dahil

Material : Die-cast aluminium body, toughened glass with 15 mm. and thermoplastic recessed box

Color : Graphite, Metallic Grey, Black
For corrosion resistance, zincrim applied to surface of the luminaire before electrostatic powder coating With LED driver

514L11

POWER LED

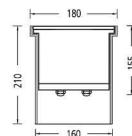

9MNK26

Ankastré Montaj Kasası / Recessed Box



IP 67



518111



MAX.20W.-35W. HIT-TC-CE G8.5

510107



MAX.75W. QPAR30 E27



Hareketli Yük Dayanımı : 2000 kg - 20 km/h
Moving Load Resistance : 2000 kg - 20 km/h



LED Tipi LED Type	Renk Isısı Color Temperature	Toplam Güç Total Power	Akım Current	Voltaj Voltage	Toplam Lümen Total Lumen
Power LED	3000K	15W	500mA	220V AC	1422lm
Power LED	4000K	15W	500mA	220V AC	1587lm
Power LED	6500K	15W	500mA	220V AC	1788lm

Malzeme : Alüminyum enjeksiyon gövde ve paslanmaz çelik ön kapak, ısıya ve basınca dayanıklı 15 mm. cam ve termoplastik ankastre montaj kasası

Renk : Mat Çelik
Armatürün yüzeyine elektrostatik toz boyadan önce korozyon direncini artırıcı zincrim uygulanır. LED sürücüsü dahil

Material : Die-cast aluminium body and stainless-steel front frame, toughened glass with 15 mm. and thermoplastic recessed box

Color : Matt Steel
For corrosion resistance, zincrim applied to surface of the luminaire before electrostatic powder coating With LED driver

514L12

POWER LED

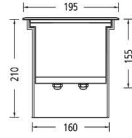

9MNK26

Ankastre Montaj Kasası / Recessed Box



IP 67



518112



MAX.20W.-35W. HIT-TC-CE G8.5

510108



MAX.75W. QPAR30 E27



Hareketli Yük Dayanımı : 2000 kg - 20 km/h
Moving Load Resistance : 2000 kg - 20 km/h



LED Tipi LED Type	Renk Isısı Color Temperature	Toplam Güç Total Power	Akım Current	Voltaj Voltage	Toplam Lümen Total Lumen
Power LED	3000K	15W	500mA	220V AC	1422lm
Power LED	4000K	15W	500mA	220V AC	1587lm
Power LED	6500K	15W	500mA	220V AC	1788lm

Malzeme : Alüminyum enjeksiyon gövde, ısıya ve basınca dayanıklı 15 mm. cam ve termoplastik ankastre montaj kasası

Renk : Mat Çelik
Armatürün yüzeyine elektrostatik toz boyadan önce korozyon direncini artırıcı zincrim uygulanır. LED sürücüsü dahil

Material : Die-cast aluminium body, toughened glass with 15 mm. and thermoplastic recessed box

Color : Matt Steel
For corrosion resistance, zincrim applied to surface of the luminaire before electrostatic powder coating With LED driver

514L13

POWER LED

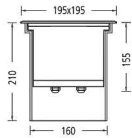

9MNK26

Ankastre Montaj Kasası / Recessed Box



IP 67



518113



MAX.20W.-35W. HIT-TC-CE G8.5

510109



MAX.75W. QPAR30 E27



Hareketli Yük Dayanımı : 2000 kg - 20 km/h
Moving Load Resistance : 2000 kg - 20 km/h

Yaşar Üniversitesi - Alsancak / İZMİR



LED Tipi LED Type	Renk Isısı Color Temperature	Toplam Güç Total Power	Akım Current	Voltaj Voltage	Toplam Lümen Total Lumen
Power LED	3000K	20W	500mA	220V AC	1896lm
Power LED	4000K	20W	500mA	220V AC	2116lm
Power LED	6500K	20W	500mA	220V AC	2384lm

Malzeme : Alüminyum enjeksiyon gövde, ısıya ve basınca dayanıklı 15 mm. cam ve termoplastik ankastre montaj kasası
Renk : Füme, Metalik Gri, Siyah
 Armatürün yüzeyine elektrostatik toz boyadan önce korozyon direncini artırıcı zincrim uygulanır. LED sürücüsü dahil
Material : Die-cast aluminium body, toughened glass with 15 mm. and thermoplastic recessed box
Color : Graphite, Metallic Grey, Black
 For corrosion resistance, zincrim applied to surface of the luminaire before electrostatic powder coating With LED driver

514L14

POWER LED

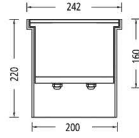

9MNK27

Ankastre Montaj Kasası / Recessed Box



IP 67



518104



MAX.35-70W.HIT-CE G12



Hareketli Yük Dayanımı : 2000 kg - 20 km/h
 Moving Load Resistance : 2000 kg - 20 km/h



LED Tipi LED Type	Renk Isısı Color Temperature	Toplam Güç Total Power	Akım Current	Voltaj Voltage	Toplam Lümen Total Lumen
Power LED	3000K	20W	500mA	220V AC	1896lm
Power LED	4000K	20W	500mA	220V AC	2116lm
Power LED	6500K	20W	500mA	220V AC	2384lm

Wallwasher

Malzeme : Alüminyum enjeksiyon gövde ve paslanmaz çelik ön kapak, ısıya ve basınca dayanıklı 15 mm. cam ve termoplastik ankastre montaj kasası
Renk : Mat Çelik
 Armatürün yüzeyine elektrostatik toz boyadan önce korozyon direncini artırıcı zincrim uygulanır. LED sürücüsü dahil
Material : Die-cast aluminium body and stainless-steel front frame, toughened glass with 15 mm. and thermoplastic recessed box
Color : Matt Steel
 For corrosion resistance, zincrim applied to surface of the luminaire before electrostatic powder coating With LED driver

514L25

POWER LED

514L26

RGB POWER LED

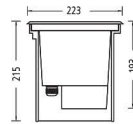

9MNK30

Ankastre Montaj Kasası / Recessed Box



IP 67



518118



MAX.35-70W.HIT-CE G12



Hareketli Yük Dayanımı : 2000 kg - 20 km/h
 Moving Load Resistance : 2000 kg - 20 km/h





LED Tipi LED Type	Renk Isısı Color Temperature	Toplam Güç Total Power	Akım Current	Voltaj Voltage	Toplam Lümen Total Lumen
Power LED	3000K	34W	700mA	220V AC	2880lm
Power LED	4000K	34W	700mA	220V AC	3648lm
Power LED	6500K	34W	700mA	220V AC	3960lm

Malzeme : Alüminyum enjeksiyon gövde ve paslanmaz çelik ön kapak, ısıya ve basınca dayanıklı
15 mm. cam ve termoplastik ankastre montaj kasası

Renk : Mat Çelik
Armatürün yüzeyine elektrostatik toz boyadan önce korozyon direncini arttırıcı zincrim uygulanır.
LED sürücüsü dahil

Material : Die-cast aluminium body and stainless-steel front frame, toughened glass with 15 mm.
and thermoplastic recessed box

Color : Matt Steel
For corrosion resistance, zincrim applied to surface of the luminaire before electrostatic powder coating
With LED driver

514L15

MIDDLE POWER LED

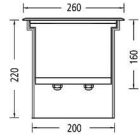

9MNK27

Ankastre Montaj Kasası / Recessed Box



IP 67



518106



MAX.35-70W.HIT-CE G12



Hareketli Yük Dayanımı : 2000 kg - 20 km/h
Moving Load Resistance : 2000 kg - 20 km/h



LED Tipi LED Type	Renk Isısı Color Temperature	Toplam Güç Total Power	Akım Current	Voltaj Voltage	Toplam Lümen Total Lumen
Power LED	3000K	45W	700mA	220V AC	3687lm
Power LED	4000K	45W	700mA	220V AC	4140lm
Power LED	6500K	45W	700mA	220V AC	4630lm

Wallwasher

Malzeme : Alüminyum enjeksiyon gövde ve paslanmaz çelik ön kapak, ısıya ve basınca dayanıklı
15 mm. cam ve termoplastik ankastre montaj kasası

Renk : Mat Çelik
Armatürün yüzeyine elektrostatik toz boyadan önce korozyon direncini arttırıcı zincrim uygulanır.
LED sürücüsü dahil

Material : Die-cast aluminium body and stainless-steel front frame, toughened glass with 15 mm.
and thermoplastic recessed box

Color : Matt Steel
For corrosion resistance, zincrim applied to surface of the luminaire before electrostatic powder coating
With LED driver

514L27

MIDDLE POWER LED

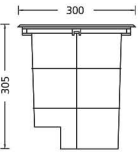

9MNK37

Ankastre Montaj Kasası / Recessed Box



IP 67



518117



MAX.70-150W.HIT-CE G12



Hareketli Yük Dayanımı : 2000 kg - 20 km/h
Moving Load Resistance : 2000 kg - 20 km/h



LED Tipi LED Type	Renk Isısı Color Temperature	Toplam Güç Total Power	Akım Current	Voltaj Voltage	Toplam Lümen Total Lumen
COB LED	3000K	10W	500mA	220V AC	948lm
COB LED	4000K	10W	500mA	220V AC	1058lm
COB LED	6500K	10W	500mA	220V AC	1192lm

Malzeme : Alüminyum enjeksiyon gövde, ısıya dayanıklı cam ve termoplastik ankastré montaj kasası
Renk : Füme, Metalik Gri, Siyah
 Armatürün yüzeyine elektrostatik toz boyadan önce korozyon direncini arttırıcı zincrim uygulanır. LED sürücüsü dahil
Material : Die-cast aluminium body, tempered glass and thermoplastic recessed box
Color : Graphite, Metallic Grey, Black
 For corrosion resistance, zincrim applied to surface of the luminaire before electrostatic powder coating With LED driver

514L16

COB LED

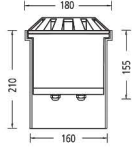

9MNK26

Ankastré Montaj Kasası / Recessed Box



IP 67



Hareketli Yük Dayanımı : 1500 kg - 10 km/h
 Moving Load Resistance : 1500 kg - 10 km/h



LED Tipi LED Type	Renk Isısı Color Temperature	Toplam Güç Total Power	Akım Current	Voltaj Voltage	Toplam Lümen Total Lumen
COB LED	3000K	10W	500mA	220V AC	948lm
COB LED	4000K	10W	500mA	220V AC	1058lm
COB LED	6500K	10W	500mA	220V AC	1192lm

Malzeme : Alüminyum enjeksiyon gövde, ısıya dayanıklı cam ve termoplastik ankastré montaj kasası
Renk : Füme, Metalik Gri, Siyah
 Armatürün yüzeyine elektrostatik toz boyadan önce korozyon direncini arttırıcı zincrim uygulanır. LED sürücüsü dahil
Material : Die-cast aluminium body, tempered glass and thermoplastic recessed box
Color : Graphite, Metallic Grey, Black
 For corrosion resistance, zincrim applied to surface of the luminaire before electrostatic powder coating With LED driver

514L17

COB LED

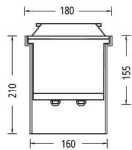

9MNK26

Ankastré Montaj Kasası / Recessed Box



IP 67



Hareketli Yük Dayanımı : 1500 kg - 10 km/h
 Moving Load Resistance : 1500 kg - 10 km/h

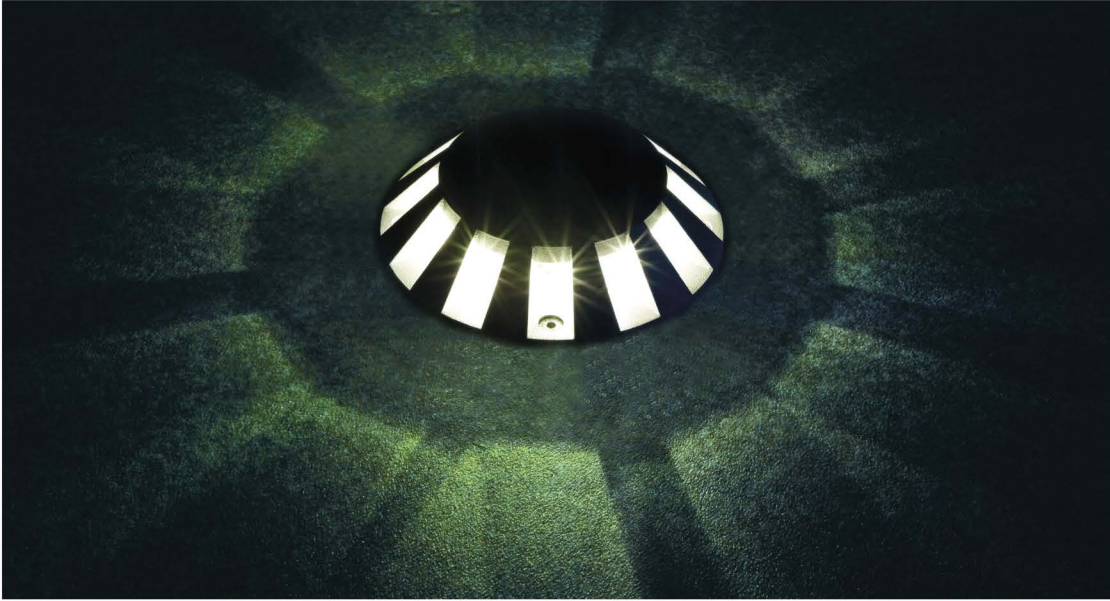



Legend Hotel - Polenezköy/ İSTANBUL



LED Tipi LED Type	Renk Isısı Color Temperature	Toplam Güç Total Power	Akım Current	Voltaj Voltage	Toplam Lümen Total Lumen
SMD LED	3000K	2W	116mA	220V AC	189lm
SMD LED	4000K	2W	116mA	220V AC	211lm
SMD LED	6500K	2W	116mA	220V AC	238lm

Malzeme : Alüminyum enjeksiyon gövde, akrilik difüzör ve galvanizli metal ankastre montaj kasası
Renk : Füme, Metalik Gri, Siyah
Armatürün yüzeyine elektrostatik toz boyadan önce korozyon direncini artırıcı zincrim uygulanır. LED sürücüsü dahil

Material : Die-cast aluminium body, acrylic diffuser and galvanized pressed steel recessed box
Color : Graphite, Metallic Grey, Black
For corrosion resistance, zincrim applied to surface of the luminaire before electrostatic powder coating With LED driver

514L18

SMD LED



9MNK16

Ankastre Montaj Kasası / Recessed Box



IP 67



Sabit Yük Dayanımı : 500 kg
Static Load Resistance : 500 kg



LED Tipi LED Type	Renk Isısı Color Temperature	Toplam Güç Total Power	Akım Current	Voltaj Voltage	Toplam Lümen Total Lumen
SMD LED	3000K	2W	116mA	220V AC	189lm
SMD LED	4000K	2W	116mA	220V AC	211lm
SMD LED	6500K	2W	116mA	220V AC	238lm

Malzeme : Alüminyum enjeksiyon gövde, akrilik difüzör ve galvanizli metal ankastre montaj kasası
Renk : Metalik Gri, Füme, Siyah
Armatürün yüzeyine elektrostatik toz boyadan önce korozyon direncini artırıcı zincrim uygulanır. LED sürücüsü dahil

Material : Die-cast aluminium body, acrylic diffuser and galvanized pressed steel recessed box
Color : Metallic Grey, Graphite, Black
For corrosion resistance, zincrim applied to surface of the luminaire before electrostatic powder coating With LED driver

514L19

SMD LED



9MNK16

Ankastre Montaj Kasası / Recessed Box



IP 67



Sabit Yük Dayanımı : 500 kg
Static Load Resistance : 500 kg



Doğa Koleji



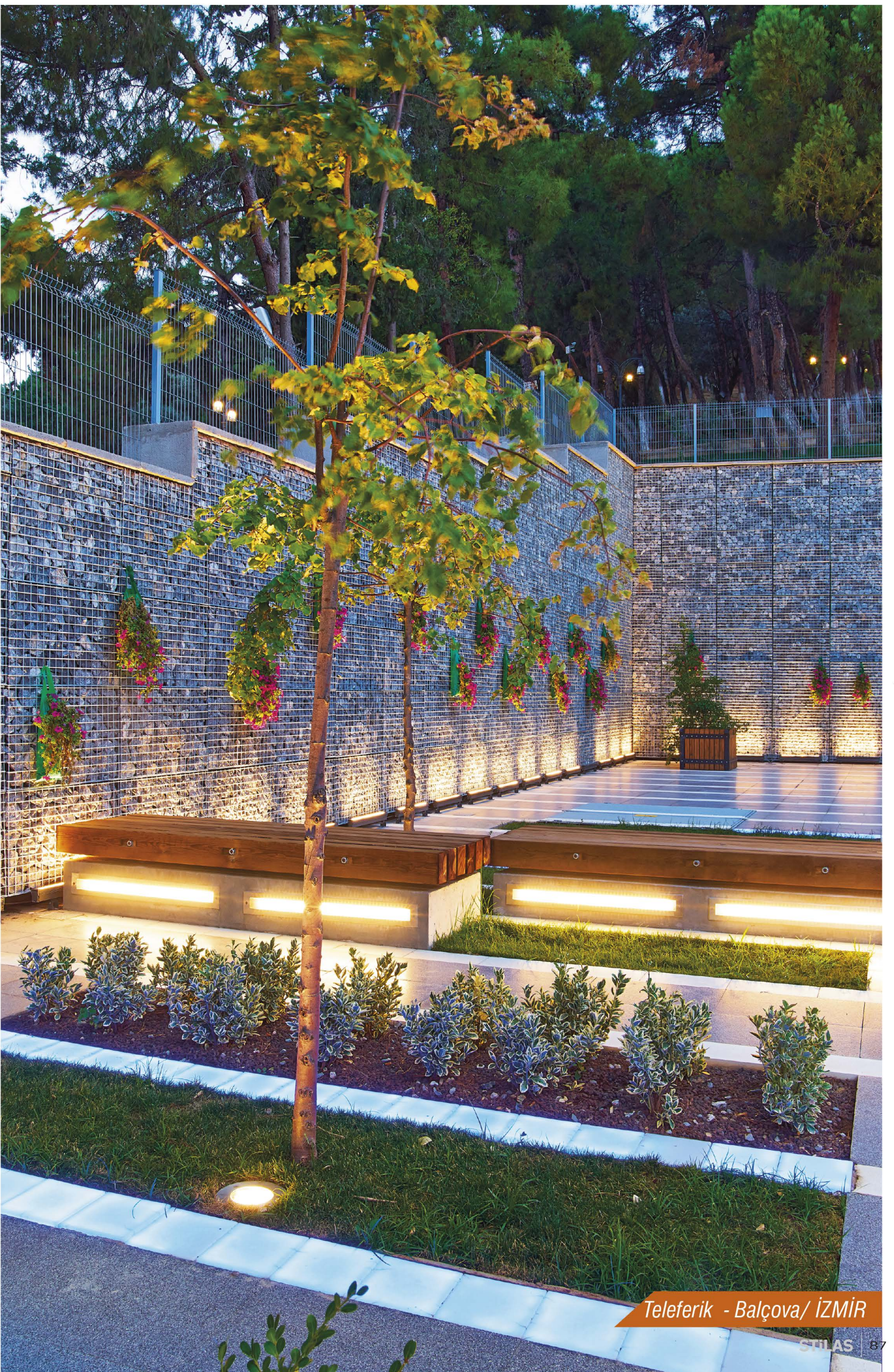

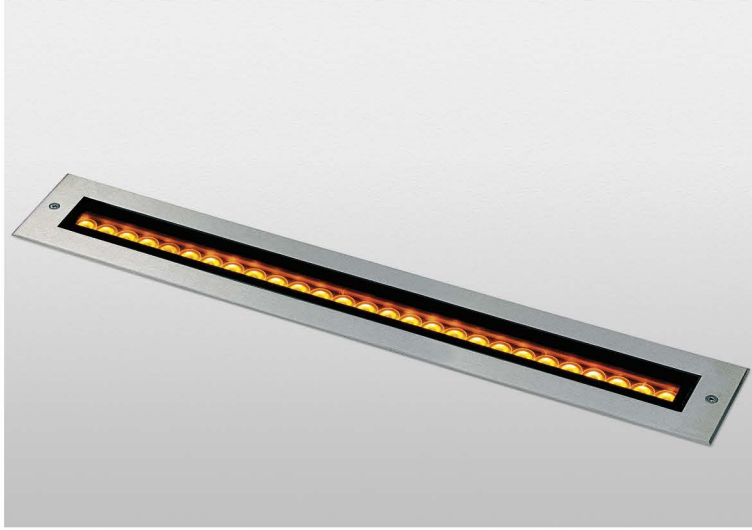

Malzeme : Alüminyum profil ve enjeksiyon gövde, paslanmaz çelik ön kapak, ısıya dayanıklı cam ve ankastre montaj kasası
 Renk : Mat Çelik
 Armatürün yüzüne elektrostatik toz boyadan önce korozyon direncini artırıcı zincoprim uygulanır
 LED sürücüsü dahil

Material : Extruded aluminium and injection body, stainless-steel front frame, tempered glass and aluminium recessed box
 Color : Matt Steel
 For corrosion resistance, zincoprim applied to surface of the luminaire before electrostatic powder coating
 With LED driver



IP 67



514L01

9 x POWER LED

9MNK22

Ankastre Montaj Kasası / Recessed Box



LED Tipi LED Type	Renk Isısı Color Temperature	Toplam Güç Total Power	Akım Current	Voltaj Voltage	Toplam Lümen Total Lumen
Power LED	3000K	10W	350mA	220V AC	1053lm
Power LED	4000K	10W	350mA	220V AC	1134lm
Power LED	6500K	10W	350mA	220V AC	1323lm

514L02

18 x POWER LED

9MNK23

Ankastre Montaj Kasası / Recessed Box

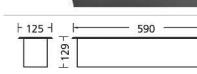

LED Tipi LED Type	Renk Isısı Color Temperature	Toplam Güç Total Power	Akım Current	Voltaj Voltage	Toplam Lümen Total Lumen
Power LED	3000K	21W	350mA	220V AC	2106lm
Power LED	4000K	21W	350mA	220V AC	2268lm
Power LED	6500K	21W	350mA	220V AC	2646lm

514L03

27 x POWER LED

9MNK24

Ankastre Montaj Kasası / Recessed Box



LED Tipi LED Type	Renk Isısı Color Temperature	Toplam Güç Total Power	Akım Current	Voltaj Voltage	Toplam Lümen Total Lumen
Power LED	3000K	32W	350mA	220V AC	3159lm
Power LED	4000K	32W	350mA	220V AC	3402lm
Power LED	6500K	32W	350mA	220V AC	3969lm

514L04

36 x POWER LED

9MNK25

Ankastre Montaj Kasası / Recessed Box



LED Tipi LED Type	Renk Isısı Color Temperature	Toplam Güç Total Power	Akım Current	Voltaj Voltage	Toplam Lümen Total Lumen
Power LED	3000K	42W	350mA	220V AC	4212lm
Power LED	4000K	42W	350mA	220V AC	4536lm
Power LED	6500K	42W	350mA	220V AC	5292lm

518108

MAX.14W. / 24W. T16 G5

9MNK12

Ankastre Montaj Kasası / Recessed Box

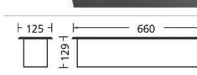

518109

MAX.21W. / 39W. T16 G5

9MNK13

Ankastre Montaj Kasası / Recessed Box



518110

MAX.28W. / 54W. T16 G5

9MNK14

Ankastre Montaj Kasası / Recessed Box



Hareketli Yük Dayanımı : 2000 kg - 20 km/h
 Moving Load Resistance : 2000 kg - 20 km/h

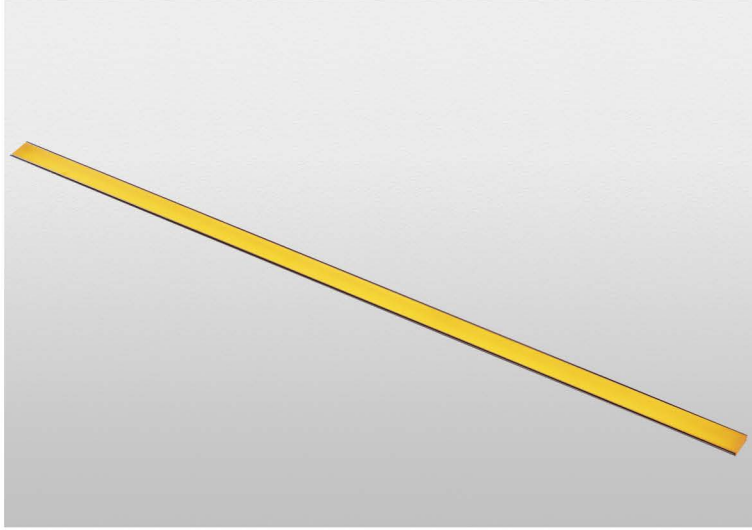

Malzeme : Dudaksız alüminyum profil ve enjeksiyon gövde,
polimer kaplama

Renk : Fülme, Metalik Gri, Siyah
Armatürün yüzüne elektrostatik toz boyadan önce
korozyon direncini arttırıcı zincoprim uygulanır
LED trafosu ile kullanılmalı

Material : Trimless aluminium profile and injection body,
polymer covering

Color : Graphite, Metallic Grey, Black
For corrosion resistance, zincoprim applied to surface
of the luminaire before electrostatic powder coating
With LED transformer



IP 67



514L31

MIDDLE POWER LED

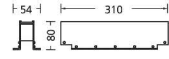

LED Tipi LED Type	Renk Isısı Color Temperature	Toplam Güç Total Power	Akım Current	Voltaj Voltage	Toplam Lümen Total Lumen
Power LED	3000K	3.4W	116mA	24V DC	216lm
Power LED	4000K	3.4W	116mA	24V DC	235lm
Power LED	6500K	3.4W	116mA	24V DC	291lm

514L32

MIDDLE POWER LED



LED Tipi LED Type	Renk Isısı Color Temperature	Toplam Güç Total Power	Akım Current	Voltaj Voltage	Toplam Lümen Total Lumen
Power LED	3000K	4.5W	116mA	24V DC	288lm
Power LED	4000K	4.5W	116mA	24V DC	319lm
Power LED	6500K	4.5W	116mA	24V DC	363lm

514L33

MIDDLE POWER LED

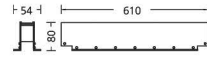

LED Tipi LED Type	Renk Isısı Color Temperature	Toplam Güç Total Power	Akım Current	Voltaj Voltage	Toplam Lümen Total Lumen
Power LED	3000K	6.7W	116mA	24V DC	432lm
Power LED	4000K	6.7W	116mA	24V DC	465lm
Power LED	6500K	6.7W	116mA	24V DC	511lm

514L34

MIDDLE POWER LED

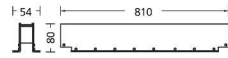

LED Tipi LED Type	Renk Isısı Color Temperature	Toplam Güç Total Power	Akım Current	Voltaj Voltage	Toplam Lümen Total Lumen
Power LED	3000K	8.9W	116mA	24V DC	576lm
Power LED	4000K	8.9W	116mA	24V DC	634lm
Power LED	6500K	8.9W	116mA	24V DC	687lm

514L35

MIDDLE POWER LED

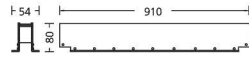

LED Tipi LED Type	Renk Isısı Color Temperature	Toplam Güç Total Power	Akım Current	Voltaj Voltage	Toplam Lümen Total Lumen
Power LED	3000K	10W	116mA	24V DC	648lm
Power LED	4000K	10W	116mA	24V DC	693lm
Power LED	6500K	10W	116mA	24V DC	735m

514L36

MIDDLE POWER LED

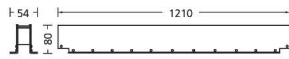

LED Tipi LED Type	Renk Isısı Color Temperature	Toplam Güç Total Power	Akım Current	Voltaj Voltage	Toplam Lümen Total Lumen
Power LED	3000K	13.3W	116mA	24V DC	864lm
Power LED	4000K	13.3W	116mA	24V DC	927lm
Power LED	6500K	13.3W	116mA	24V DC	979lm



Hareketli Yük Dayanımı : 2000 kg - 20 km/h
Moving Load Resistance : 2000 kg - 20 km/h



STILAS

Exterior Luminaires

Dış Aydınlatma Armatürleri



Kısa Tip Bahçe - Park Armatürleri

Bollards



MYSIA

LED Tipi LED Type	Renk Isısı Color Temperature	Toplam Güç Total Power	Akım Current	Voltaj Voltage	Toplam Lümen Total Lumen
Middle Power LED	3000K	22W	116mA	220V AC	1905lm
Middle Power LED	4000K	22W	116mA	220V AC	2087lm

Malzeme : Alüminyum profil ve enjeksiyon gövde, alüminyum reflektör ve polikarbonat difüzör, galvanizli metal ankraj
Renk : Füme, Metalik Gri, Siyah
 Armatürün yüzeyine elektrostatik toz boyadan önce korozyon direncini arttırıcı zincoprım uygulanır. LED sürücüsü dahil

Material : Die-cast aluminium and extruded body, aluminium reflector and polycarbonate diffuser, galvanized metal anchorage
Color : Graphite, Metallic Grey, Black
 For corrosion resistance, zincoprım applied to surface of the luminaire before electrostatic powder coating. With LED driver

540L01

MIDDLE POWER LED

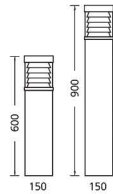
9ANK03

Ankraj / Anchorage



IP 65

549102

MAX.26W. G24d3

549103

MAX.35W. HIT-CE G12

540108

MAX.20W. TC-TSE E27



Dis Aydınlatma Acenteleri | Exterior Luminaire



Çan Otel - ÇANAĞKALE



MYSIA

LED Tipi LED Type	Renk Isısı Color Temperature	Toplam Güç Total Power	Akım Current	Voltaj Voltage	Toplam Lümen Total Lumen
Middle Power LED	3000K	22W	116mA	220V AC	1905lm
Middle Power LED	4000K	22W	116mA	220V AC	2087lm

Malzeme : Alüminyum profil ve enjeksiyon gövde, akrilik difüzör, galvanizli metal ankraj

Renk : Füme, Metalik Gri, Siyah

Armatürün yüzeyine elektrostatik toz boyadan önce korozyon direncini arttırıcı zincoprım uygulanır
LED sürücüsü dahil

Material : Die-cast aluminium and extruded body, acrylic diffuser, galvanized metal anchorage

Color : Graphite, Metallic Grey, Black

For corrosion resistance, zincoprım applied to surface of the luminaire before electrostatic powder coating
With LED driver

540L02

MIDDLE POWER LED

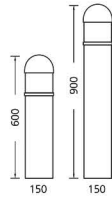

9ANK03

Ankraj / Anchorage



IP 65



549146



MAX.26W. G24d3

540112



MAX.20W. TC-TSE E27



PAPULUS

LED Tipi LED Type	Renk Isısı Color Temperature	Toplam Güç Total Power	Akım Current	Voltaj Voltage	Toplam Lümen Total Lumen
Middle Power LED	3000K	22W	116mA	220V AC	1905lm
Middle Power LED	4000K	22W	116mA	220V AC	2087lm

Malzeme : Alüminyum profil ve enjeksiyon gövde, alüminyum reflektör ve akrilik difüzör,
galvanizli metal ankraj

Renk : Füme, Metalik Gri, Siyah
Armatürün yüzeyine elektrostatik toz boyadan önce korozyon direncini arttırıcı zincoprım uygulanır
LED sürücüsü dahil

Material : Die-cast aluminium and extruded body, aluminium reflector and acrylic diffuser,
galvanized metal anchorage

Color : Graphite, Metallic Grey, Black
For corrosion resistance, zincoprım applied to surface of the luminaire before electrostatic powder coating
With LED driver

540L03

MIDDLE POWER LED



9ANK12

Ankraj / Anchorage

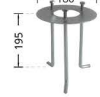

IP 65



549124



MAX.35W. HIT-CE G12

549126



MAX.26W. G24d3



MELIA

LED Tipi LED Type	Renk Isısı Color Temperature	Toplam Güç Total Power	Akım Current	Voltaj Voltage	Toplam Lümen Total Lumen
Middle Power LED	3000K	22W	116mA	220V AC	1905lm
Middle Power LED	4000K	22W	116mA	220V AC	2087lm

Malzeme : Alüminyum profil ve enjeksiyon gövde, alüminyum reflektör ve akrilik difüzör,
galvanizli metal ankraj

Renk : Füme, Metalik Gri, Siyah
Armatürün yüzeyine elektrostatik toz boyadan önce korozyon direncini arttırıcı zincoprüm uygulanır
LED sürücüsü dahil

Material : Die-cast aluminium and extruded body, aluminium reflector and acrylic diffuser,
galvanized metal anchorage

Color : Graphite, Metallic Grey, Black
For corrosion resistance, zincoprüm applied to surface of the luminaire before electrostatic powder coating
With LED driver

540L04

MIDDLE POWER LED



9ANK12

Ankraj / Anchorage



IP 65



549117



MAX.26W. G24d3

540115



MAX.20W. TC-TSE E27

PLATANUS



LED Tipi LED Type	Renk Isısı Color Temperature	Toplam Güç Total Power	Akım Current	Voltaj Voltage	Toplam Lümen Total Lumen
Power LED	3000K	15W	500mA	220V AC	1422lm
Power LED	4000K	15W	500mA	220V AC	1587lm
Power LED	6500K	15W	500mA	220V AC	1788lm

Malzeme : Alüminyum profil ve enjeksiyon gövde, ısıya dayanıklı cam, galvanizli metal ankraj
Renk : Füme, Metalik Gri, Siyah
Armatürün yüzeyine elektrostatik toz boyadan önce korozyon direncini artırıcı zincoprım uygulanır
LED sürücüsü dahil

Material : Die-cast aluminium and extruded body, tempered glass, galvanized metal anchorage
Color : Graphite, Metallic Grey, Black
For corrosion resistance, zincoprım applied to surface of the luminaire before electrostatic powder coating
With LED driver

540L05

POWER LED

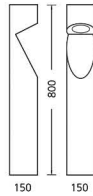

9ANK03

Ankraj / Anchorage



IP 65





LARIX

LED Tipi LED Type	Renk Isısı Color Temperature	Toplam Güç Total Power	Akım Current	Voltaj Voltage	Toplam Lümen Total Lumen
Power LED	3000K	12W	500mA	220V AC	1138lm
Power LED	4000K	12W	500mA	220V AC	1270lm
Power LED	6500K	12W	500mA	220V AC	1430lm

Malzeme : Alüminyum profil ve enjeksiyon gövde, ısıya dayanıklı cam, galvanizli metal ankraj

Renk : Füme, Metalik Gri, Siyah

Armatürün yüzeyine elektrostatik toz boyadan önce korozyon direncini artırıcı zincoprım uygulanır
LED sürücüsü dahil

Material : Die-cast aluminium and extruded body, tempered glass, galvanized metal anchorage

Color : Graphite, Metallic Grey, Black

For corrosion resistance, zincoprım applied to surface of the luminaire before electrostatic powder coating
With LED driver

540L07

POWER LED

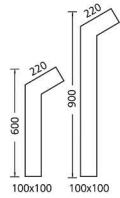

9ANK02

Ankraj / Anchorage



IP 65



549120



MAX.26W. G24d3

540110



MAX.20W. TC-TSE E27



MUSHROOM

LED Tipi LED Type	Renk Isısı Color Temperature	Toplam Güç Total Power	Akım Current	Voltaj Voltage	Toplam Lümen Total Lumen
Power LED	3000K	20W	500mA	220V AC	1896lm
Power LED	4000K	20W	500mA	220V AC	2116lm
Power LED	6500K	20W	500mA	220V AC	2384lm

Malzeme : Alüminyum profil ve enjeksiyon gövde, akrilik difüzör, galvanizli metal ankraj

Renk : Füme, Metalik Gri, Siyah

Armatürün yüzeyine elektrostatik toz boyadan önce korozyon direncini arttırıcı zincoprım uygulanır
LED sürücüsü dahil

Material : Die-cast aluminium and extruded body, acrylic diffuser, galvanized metal anchorage

Color : Graphite, Metallic Grey, Black

For corrosion resistance, zincoprım applied to surface of the luminaire before electrostatic powder coating
With LED driver

540L06

POWER LED



9ANK03

Ankraj / Anchorage



IP 65



549117



MAX.35W. HIT-CE G12



MYSIA

LED Tipi LED Type	Renk Isısı Color Temperature	Toplam Güç Total Power	Akım Current	Voltaj Voltage	Toplam Lümen Total Lumen
Middle Power LED	3000K	22W	116mA	220V AC	1905lm
Middle Power LED	4000K	22W	116mA	220V AC	2087lm

Malzeme : Alüminyum profil ve enjeksiyon gövde, alüminyum reflektör ve polikarbonat difüzör, galvanizli metal ankraj
Renk : Füme, Metalik Gri, Siyah
 Armatürün yüzeyine elektrostatik toz boyadan önce korzyon direncini arttırıcı zincoprım uygulanır
 LED sürücüsü dahil

Material : Die-cast aluminium and extruded body, aluminium reflector and polycarbonate diffuser, galvanized metal anchorage
Color : Graphite, Metallic Grey, Black
 For corrosion resistance, zincoprım applied to surface of the luminaire before electrostatic powder coating
 With LED driver

540L08

MIDDLE POWER LED

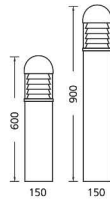

9ANK03

Ankraj / Anchorage



IP 65



549118



MAX.35W. HIT-CE G12

549119



MAX.26W. G24d3

540109



MAX.20W. TC-TSE E27



GINEPRO

LED Tipi LED Type	Renk Isısı Color Temperature	Toplam Güç Total Power	Akım Current	Voltaj Voltage	Toplam Lümen Total Lumen
COB LED	3000K	10W	500mA	220V AC	940lm
COB LED	4000K	10W	500mA	220V AC	995lm
COB LED	6500K	10W	500mA	220V AC	1085lm

Malzeme : Alüminyum profil ve enjeksiyon gövde, ısıya dayanıklı cam, galvanizli metal ankraj
Renk : Füme, Metalik Gri, Siyah
Armatürün yüzeyine elektrostatik toz boyadan önce korozyon direncini artırıcı zincoprım uygulanır.
LED sürücüsü dahil

Material : Die-cast aluminium and extruded body, tempered glass, galvanized metal anchorage
Color : Graphite, Metallic Grey, Black
For corrosion resistance, zincoprım applied to surface of the luminaire before electrostatic powder coating
With LED driver

540L09

COB LED

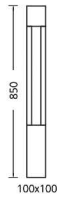
**9ANK02**

Ankraj / Anchorage



IP 65



ALNUS

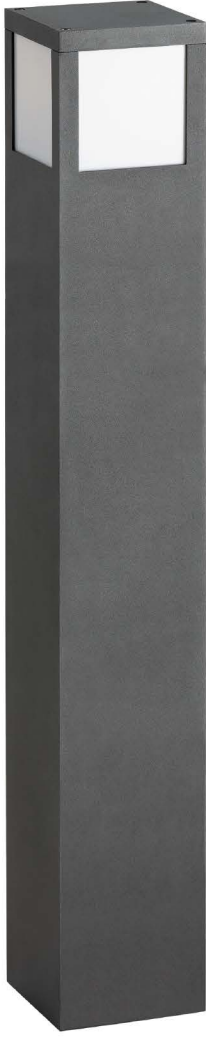

LED Tipi LED Type	Renk Isısı Color Temperature	Toplam Güç Total Power	Akım Current	Voltaj Voltage	Toplam Lümen Total Lumen
Middle Power LED	3000K	22W	116mA	220V AC	1905lm
Middle Power LED	4000K	22W	116mA	220V AC	2087lm

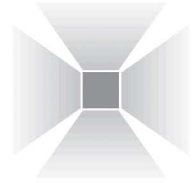

Malzeme : Alüminyum profil ve enjeksiyon gövde, akrilik difüzör, galvanizli metal ankraj

Renk : Füme, Metalik Gri, Siyah

Armatürün yüzeyine elektrostatik toz boyadan önce korozyon direncini arttırıcı zincoprım uygulanır
LED sürücüsü dahil

Material : Die-cast aluminium and extruded body, acrylic diffuser, galvanized metal anchorage

Color : Graphite, Metallic Grey, Black

For corrosion resistance, zincoprım applied to surface of the luminaire before electrostatic powder coating
With LED driver

540L11

MIDDLE POWER LED

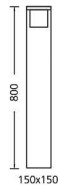

9ANK09

Ankraj / Anchorage



IP 65



549147



MAX.26W. G24d3

540114



MAX.20W. TC-TSE E27



FAGUS

LED Tipi LED Type	Renk Isısı Color Temperature	Toplam Güç Total Power	Akım Current	Voltaj Voltage	Toplam Lümen Total Lumen
Middle Power LED	3000K	11W	116mA	220V AC	953lm
Middle Power LED	4000K	11W	116mA	220V AC	1044lm

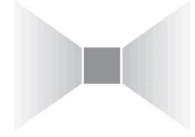

Malzeme : Alüminyum profil ve enjeksiyon gövde, akrilik difüzör, galvanizli metal ankraj

Renk : Füme, Metalik Gri, Siyah

Armatürün yüzeyine elektrostatik toz boyadan önce korozyon direncini arttırıcı zincoprım uygulanır
LED sürücüsü dahil

Material : Die-cast aluminium and extruded body, acrylic diffuser, galvanized metal anchorage

Color : Graphite, Metallic Grey, Black

For corrosion resistance, zincoprım applied to surface of the luminaire before electrostatic powder coating
With LED driver

540L10

MIDDLE POWER LED

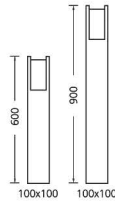

9ANK02

Ankraj / Anchorage



IP 54



540106



MAX.20W. TC-TSE E27



Sir Giyim - Sarnıç/ İZMİR



KORINT

LED Tipi LED Type	Renk Isısı Color Temperature	Toplam Güç Total Power	Akım Current	Voltaj Voltage	Toplam Lümen Total Lumen
Middle Power LED	3000K	11W	116mA	220V AC	953lm
Middle Power LED	4000K	11W	116mA	220V AC	1044lm

Malzeme : Üst baslık alüminyum enjeksiyon ve akrilik difüzör, çelik boru direk gövdesi,
galvanizli metal ankraj

Renk : Füme, Metalik Gri, Siyah
Armatürün yüzeyine elektrostatik toz boyadan önce korozyon direncini arttırıcı zincoprım uygulanır
LED sürücüsü dahil

Material : Die-cast aluminium and acrylic diffuser upper head, pole body made of steel tube,
galvanized metal anchorage

Color : Graphite, Metallic Grey, Black
For corrosion resistance, zincoprım applied to surface of the luminaire before electrostatic powder coating
With LED driver

540L12

MIDDLE POWER LED

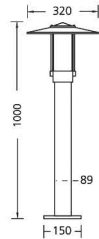
**9ANK01**

Ankraj / Anchorage



IP 54





FAGUS

LED Tipi LED Type	Renk Isısı Color Temperature	Toplam Güç Total Power	Akım Current	Voltaj Voltage	Toplam Lümen Total Lumen
Middle Power LED	3000K	22W	116mA	220V AC	1905lm
Middle Power LED	4000K	22W	116mA	220V AC	2087lm

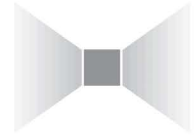

Malzeme : Alüminyum profil ve enjeksiyon gövde, akrilik difüzör, galvanizli metal ankraj

Renk : Füme, Metalik Gri, Siyah

Armatürün yüzeyine elektrostatik toz boyadan önce korozyon direncini arttırıcı zincrim uygulanır
LED sürücüsü dahil

Material : Die-cast aluminium and extruded body, acrylic diffuser, galvanized metal anchorage

Color : Graphite, Metallic Grey, Black

For corrosion resistance, zincrim applied to surface of the luminaire before electrostatic powder coating
With LED driver

540L13

MIDDLE POWER LED



9ANK02

Ankraj / Anchorage



IP 54



549121



MAX:36W. TC-L 2G11



CEDRUS

LED Tipi LED Type	Renk Isısı Color Temperature	Toplam Güç Total Power	Akım Current	Voltaj Voltage	Toplam Lümen Total Lumen
Middle Power LED	3000K	22W	116mA	220V AC	1905lm
Middle Power LED	4000K	22W	116mA	220V AC	2087lm

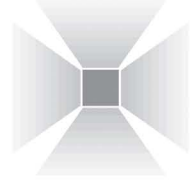

Malzeme : Alüminyum profil ve enjeksiyon gövde, akrilik difüzör, galvanizli metal ankraj

Renk : Füme, Metalik Gri, Siyah

Armatürün yüzeyine elektrostatik toz boyadan önce korozyon direncini artırıcı zincoprım uygulanır
LED sürücüsü dahil

Material : Die-cast aluminium and extruded body, acrylic diffuser, galvanized metal anchorage

Color : Graphite, Metallic Grey, Black

For corrosion resistance, zincoprım applied to surface of the luminaire before electrostatic powder coating
With LED driver

540L14

MIDDLE POWER LED

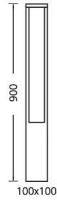

9ANK09

Ankraj / Anchorage



IP 54



549144



MAX:36W. TC-L 2G11



BETULA

LED Tipi LED Type	Renk Isısı Color Temperature	Toplam Güç Total Power	Akım Current	Voltaj Voltage	Toplam Lümen Total Lumen
Middle Power LED	3000K	8W	116mA	220V AC	660lm
Middle Power LED	4000K	8W	116mA	220V AC	730lm

Malzeme : Alüminyum profil ve enjeksiyon gövde, akrilik difüzör, galvanizli metal ankraj

Renk : Füme, Metalik Gri, Siyah

Armatürün yüzeyine elektrostatik toz boyadan önce korozyon direncini arttırıcı zincoprım uygulanır
LED sürücüsü dahil

Material : Die-cast aluminium and extruded body, acrylic diffuser, galvanized metal anchorage

Color : Graphite, Metallic Grey, Black

For corrosion resistance, zincoprım applied to surface of the luminaire before electrostatic powder coating
With LED driver

540L15

MIDDLE POWER LED

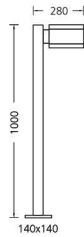

9ANK09

Ankraj / Anchorage



IP 65



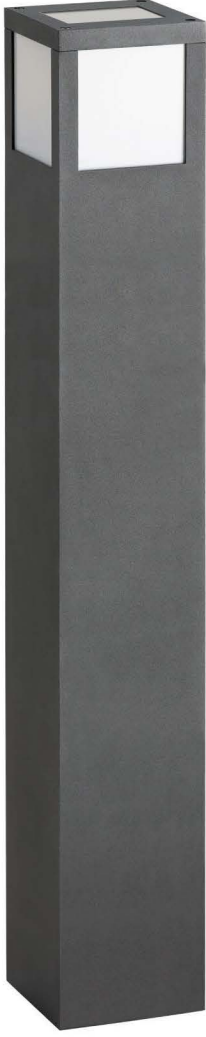

ALBIZIA

LED Tipi LED Type	Renk Isısı Color Temperature	Toplam Güç Total Power	Akım Current	Voltaj Voltage	Toplam Lümen Total Lumen
Power LED	3000K	20W	500mA	220V AC	1896lm
Power LED	4000K	20W	500mA	220V AC	2116lm
Power LED	6500K	20W	500mA	220V AC	2384lm

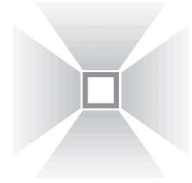

Malzeme : Alüminyum profil ve enjeksiyon gövde, akrilik difüzör, galvanizli metal ankraj

Renk : Füme, Metalik Gri, Siyah

Armatürün yüzeyine elektrostatik toz boyadan önce korozyon direncini artırıcı zincoprım uygulanır
LED sürücüsü dahil

Material : Die-cast aluminium and extruded body, acrylic diffuser, galvanized metal anchorage

Color : Graphite, Metallic Grey, Black

For corrosion resistance, zincoprım applied to surface of the luminaire before electrostatic powder coating
With LED driver

540L16

POWER LED

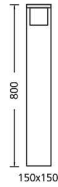

9ANK09

Ankraj / Anchorage



IP 65



549149



MAX.26W. G24d3

540117



MAX.20W. TC-TSE E27



PUNICA

LED Tipi LED Type	Renk Isısı Color Temperature	Toplam Güç Total Power	Akım Current	Voltaj Voltage	Toplam Lümen Total Lumen
Power LED	3000K	15W	500mA	220V AC	1422lm
Power LED	4000K	15W	500mA	220V AC	1587lm
Power LED	6500K	15W	500mA	220V AC	1788lm

Malzeme : Alüminyum profil ve enjeksiyon gövde, akrilik difüzör, galvanizli metal ankraj

Renk : Füme, Metalik Gri, Siyah

Armatürün yüzeyine elektrostatik toz boyadan önce korozyon direncini arttırıcı zincoprüm uygulanır
LED sürücüsü dahil

Material : Die-cast aluminium and extruded body, acrylic diffuser, galvanized metal anchorage

Color : Graphite, Metallic Grey, Black

For corrosion resistance, zincoprüm applied to surface of the luminaire before electrostatic powder coating
With LED driver

540L17

POWER LED

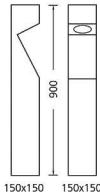

9ANK09

Ankraj / Anchorage



IP 65





CORNUS

LED Tipi LED Type	Renk Isısı Color Temperature	Toplam Güç Total Power	Akım Current	Voltaj Voltage	Toplam Lümen Total Lumen
Middle Power LED	3000K	11W	116mA	220V AC	953lm
Middle Power LED	4000K	11W	116mA	220V AC	1044lm

Malzeme : Alüminyum profil ve enjeksiyon gövde, akrilik difüzör, galvanizli metal ankraj

Renk : Füme, Metalik Gri, Siyah

Armatürün yüzeyine elektrostatik toz boyadan önce korozyon direncini arttırıcı zincoprım uygulanır
LED sürücüsü dahil

Material : Die-cast aluminium and extruded body, acrylic diffuser, galvanized metal anchorage

Color : Graphite, Metallic Grey, Black

For corrosion resistance, zincoprım applied to surface of the luminaire before electrostatic powder coating
With LED driver

540L18

MIDDLE POWER LED

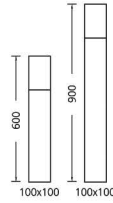

9ANK09

Ankraj / Anchorage



IP 54



540105



MAX.20W. TC-TSE E27

TETRA



LED Tipi LED Type	Renk Isısı Color Temperature	Toplam Güç Total Power	Akım Current	Voltaj Voltage	Toplam Lümen Total Lumen
COB LED	3000K	8W	300mA	220V AC	669lm
COB LED	4000K	8W	300mA	220V AC	700lm

Malzeme : Alüminyum profil ve enjeksiyon gövde, akrilik difüzör, galvanizli metal ankraj

Renk : Füme, Metalik Gri, Siyah

Armatürün yüzeyine elektrostatik toz boyadan önce korozyon direncini arttırıcı zincoprım uygulanır
LED sürücüsü dahil

Material : Die-cast aluminium and extruded body, acrylic diffuser, galvanized metal anchorage

Color : Graphite, Metallic Grey, Black

For corrosion resistance, zincoprım applied to surface of the luminaire before electrostatic powder coating
With LED driver

540L19

POWER LED

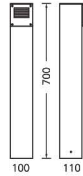

9ANK09

Ankraj / Anchorage



IP 54





GINEPRO

LED Tipi LED Type	Renk Isısı Color Temperature	Toplam Güç Total Power	Akım Current	Voltaj Voltage	Toplam Lümen Total Lumen
COB LED	3000K	21W	500mA	220V AC	2260lm
COB LED	4000K	21W	500mA	220V AC	2456lm
COB LED	6500K	21W	500mA	220V AC	2456lm

Malzeme : Alüminyum profil ve enjeksiyon gövde, ısıya dayanıklı cam, galvanizli metal ankraj

Renk : Füme, Metalik Gri, Siyah

Armatürün yüzeyine elektrostatik toz boyadan önce korozyon direncini artırıcı zincoprim uygulanır.
LED sürücüsü dahil

Material : Die-cast aluminium and extruded body, tempered glass, galvanized metal anchorage

Color : Graphite, Metallic Grey, Black

For corrosion resistance, zincoprim applied to surface of the luminaire before electrostatic powder coating
With LED driver

540L20

COB LED

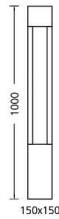

9ANK09

Ankraj / Anchorage



IP 65



549125



MAX.35W. HIT-TC-CE GU6.5



NERIUM

LED Tipi LED Type	Renk Isısı Color Temperature	Toplam Güç Total Power	Akım Current	Voltaj Voltage	Toplam Lümen Total Lumen
Middle Power LED	3000K	8W	116mA	220V AC	660lm
Middle Power LED	4000K	8W	116mA	220V AC	730lm

Malzeme : Alüminyum profil ve enjeksiyon gövde, akrilik difüzör, galvanizli metal ankraj

Renk : Füme, Metalik Gri, Siyah

Armatürün yüzeyine elektrostatik toz boyadan önce korozyon direncini arttırıcı zincoprım uygulanır
LED sürücüsü dahil

Material : Die-cast aluminium and extruded body, acrylic diffuser, galvanized metal anchorage

Color : Graphite, Metallic Grey, Black

For corrosion resistance, zincoprım applied to surface of the luminaire before electrostatic powder coating
With LED driver

540L21

MIDDLE POWER LED

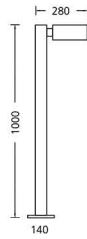

9ANK03

Ankraj / Anchorage



IP 65





MYSIA

LED Tipi LED Type	Renk Isısı Color Temperature	Toplam Güç Total Power	Akım Current	Voltaj Voltage	Toplam Lümen Total Lumen
Middle Power LED	3000K	22W	116mA	220V AC	1905lm
Middle Power LED	4000K	22W	116mA	220V AC	2087lm

Malzeme : Alüminyum profil ve enjeksiyon gövde, alüminyum reflektör ve akrilik difüzör,
galvanizli metal ankraj

Renk : Füme, Metalik Gri, Siyah
Armatürün yüzeyine elektrostatik toz boyadan önce korozyon direncini arttırıcı zincoprım uygulanır.
LED sürücüsü dahil

Material : Die-cast aluminium and extruded body, aluminium reflector and acrylic diffuser,
galvanized metal anchorage

Color : Graphite, Metallic Grey, Black
For corrosion resistance, zincoprım applied to surface of the luminaire before electrostatic powder coating
With LED driver

540L23

MIDDLE POWER LED

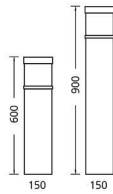

9ANK03

Ankraj / Anchorage



IP 65



549145



MAX.26W. G24d3

540111



MAX.20W. TC-TSE E27



Dış Aydınlatma Armatürleri | Exterior Luminaires

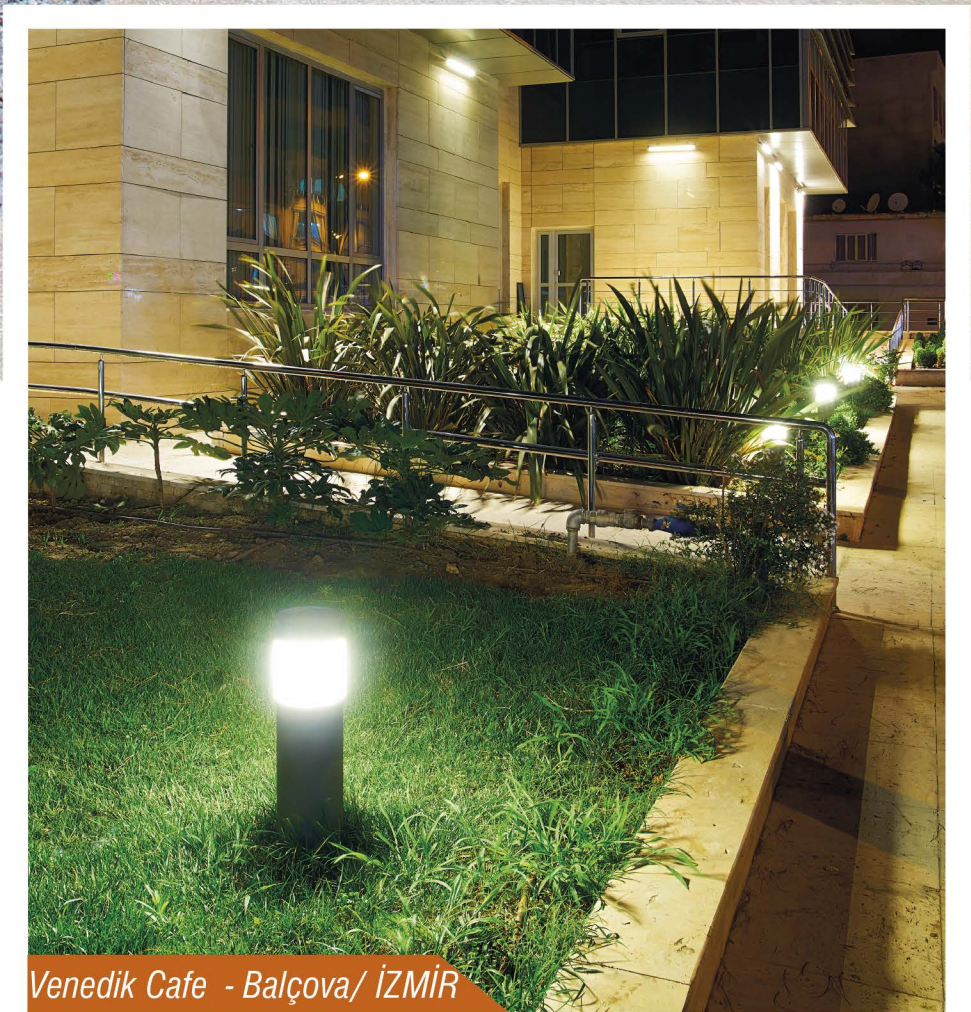

Venedik Cafe - Balçova/ İZMİR

SQUARE MUSHROOM



LED Tipi LED Type	Renk Isısı Color Temperature	Toplam Güç Total Power	Akım Current	Voltaj Voltage	Toplam Lümen Total Lumen
Power LED	3000K	20W	500mA	220V AC	1896lm
Power LED	4000K	20W	500mA	220V AC	2116lm
Power LED	6500K	20W	500mA	220V AC	2384lm



Malzeme : Alüminyum profil ve enjeksiyon gövde, akrilik difüzör, galvanizli metal ankraj

Renk : Füme, Metalik Gri, Siyah

Armatürün yüzeyine elektrostatik toz boyadan önce korozyon direncini arttırıcı zincoprım uygulanır
LED sürücüsü dahil

Material : Die-cast aluminium and extruded body, acrylic diffuser, galvanized metal anchorage

Color : Graphite, Metallic Grey, Black

For corrosion resistance, zincoprım applied to surface of the luminaire before electrostatic powder coating
With LED driver

540L22

POWER LED

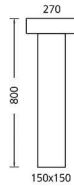

9ANK09

Ankraj / Anchorage



IP 65



549117



MAX.35W. HIT-CE G12

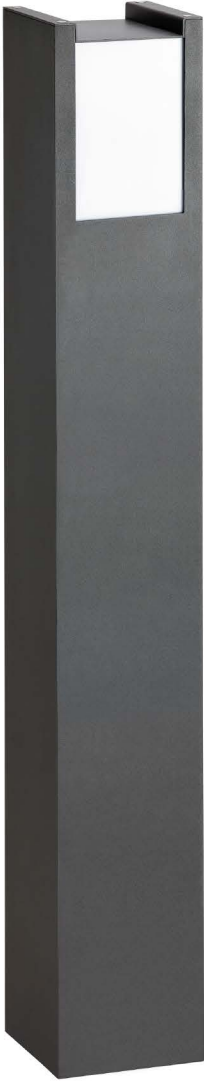

FAGUS

LED Tipi LED Type	Renk Isısı Color Temperature	Toplam Güç Total Power	Akım Current	Voltaj Voltage	Toplam Lümen Total Lumen
Middle Power LED	3000K	17W	116mA	220V AC	1670lm
Middle Power LED	4000K	17W	116mA	220V AC	1735lm

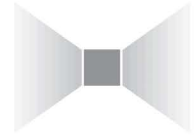

Malzeme : Alüminyum profil ve enjeksiyon gövde, akrilik difüzör, galvanizli metal ankraj

Renk : Füme, Metalik Gri, Siyah

Armatürün yüzeyine elektrostatik toz boyadan önce korozyon direncini arttırıcı zincoprım uygulanır
LED sürücüsü dahil

Material : Die-cast aluminium and extruded body, acrylic diffuser, galvanized metal anchorage

Color : Graphite, Metallic Grey, Black

For corrosion resistance, zincoprım applied to surface of the luminaire before electrostatic powder coating
With LED driver

540L24

MIDDLE POWER LED

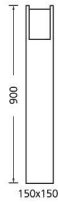

9ANK09

Ankraj / Anchorage



IP 54



549123



MAX.26W. G24d3

540113



MAX.20W. TC-TSE E27



FAGUS

LED Tipi LED Type	Renk Isısı Color Temperature	Toplam Güç Total Power	Akım Current	Voltaj Voltage	Toplam Lümen Total Lumen
Middle Power LED	3000K	22W	116mA	220V AC	1905lm
Middle Power LED	4000K	22W	116mA	220V AC	2087lm

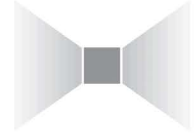

Malzeme : Alüminyum profil ve enjeksiyon gövde, akrilik difüzör, galvanizli metal ankraj

Renk : Füme, Metalik Gri, Siyah

Armatürün yüzeyine elektrostatik toz boyadan önce korozyon direncini arttırıcı zincoprım uygulanır
LED sürücüsü dahil

Material : Die-cast aluminium and extruded body, acrylic diffuser, galvanized metal anchorage

Color : Graphite, Metallic Grey, Black

For corrosion resistance, zincoprım applied to surface of the luminaire before electrostatic powder coating
With LED driver

540L25

MIDDLE POWER LED

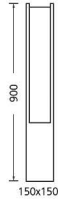

9ANK09

Ankraj / Anchorage



IP 54



549216



MAX.2x24W. T16 G5



Yüksek Teknoloji Enstitüsü - Urla/ İZMİR



CEDRUS

LED Tipi LED Type	Renk Isısı Color Temperature	Toplam Güç Total Power	Akım Current	Voltaj Voltage	Toplam Lümen Total Lumen
Middle Power LED	3000K	22W	116mA	220V AC	1905lm
Middle Power LED	4000K	22W	116mA	220V AC	2087lm

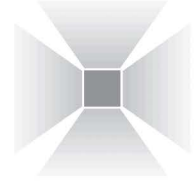

Malzeme : Alüminyum profil ve enjeksiyon gövde, akrilik difüzör, galvanizli metal ankraj

Renk : Füme, Metalik Gri, Siyah

Armatürün yüzeyine elektrostatik toz boyadan önce korozyon direncini artırıcı zincrim uygulanır.
LED sürücüsü dahil

Material : Die-cast aluminium and extruded body, acrylic diffuser, galvanized metal anchorage

Color : Graphite, Metallic Grey, Black

For corrosion resistance, zincrim applied to surface of the luminaire before electrostatic powder coating
With LED driver

540L26

MIDDLE POWER LED

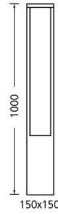

9ANK09

Ankraj / Anchorage



IP 54



549217



MAX.2x24W. T16 G5



SALICE

LED Tipi LED Type	Renk Isısı Color Temperature	Toplam Güç Total Power	Akım Current	Voltaj Voltage	Toplam Lümen Total Lumen
Middle Power LED	3000K	22W	116mA	220V AC	1905lm
Middle Power LED	4000K	22W	116mA	220V AC	2087lm

Malzeme : Alüminyum profil ve enjeksiyon gövde, akrilik difüzör, galvanizli metal ankraj

Renk : Füme, Metalik Gri, Siyah

Armatürün yüzeyine elektrostatik toz boyadan önce korozyon direncini arttırıcı zincoprım uygulanır
LED sürücüsü dahil

Material : Die-cast aluminium and extruded body, acrylic diffuser, galvanized metal anchorage

Color : Graphite, Metallic Grey, Black

For corrosion resistance, zincoprım applied to surface of the luminaire before electrostatic powder coating
With LED driver

540L27

MIDDLE POWER LED

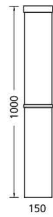

9ANK03

Ankraj / Anchorage



IP 65



549219



MAX.2x24W. T16 G5



MORUS

LED Tipi LED Type	Renk Isısı Color Temperature	Toplam Güç Total Power	Akım Current	Voltaj Voltage	Toplam Lümen Total Lumen
Middle Power LED	3000K	11W	116mA	220V AC	953lm
Middle Power LED	4000K	11W	116mA	220V AC	1044lm

Malzeme : Alüminyum profil gövde ve pres cam, galvanizli metal ankraj

Renk : Füme, Metalik Gri, Siyah

Armatürün yüzeyine elektostatik toz boyadan önce korozyon direncini arttırıcı zincrim uygulanır
LED sürücüsü dahil

Material : Extruded aluminium body and pressed glass, galvanized metal anchorage

Color : Graphite, Metallic Grey, Black

For corrosion resistance, zincrim applied to surface of the luminaire before electrostatic powder coating
With LED driver

540L29

MIDDLE POWER LED

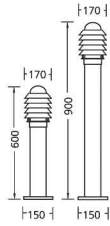

9ANK01

Ankraj / Anchorage



IP 44



540102



MAX.20W. TC-T5E E27



Yaşar Üniversitesi - Alsancak / İZMİR



KALMIA

LED Tipi LED Type	Renk Isısı Color Temperature	Toplam Güç Total Power	Akım Current	Voltaj Voltage	Toplam Lümen Total Lumen
Middle Power LED	3000K	11W	116mA	220V AC	953lm
Middle Power LED	4000K	11W	116mA	220V AC	1044lm

Malzeme : Alüminyum profil gövde ve pres cam, galvanizli metal ankraj

Renk : Füme, Metalik Gri, Siyah

Armatürün yüzeyine elektrostatik toz boyadan önce korozyon direncini arttırıcı zincoprım uygulanır
LED sürücüsü dahil

Material : Extruded aluminium body and pressed glass, galvanized metal anchorage

Color : Graphite, Metallic Grey, Black

For corrosion resistance, zincoprım applied to surface of the luminaire before electrostatic powder coating
With LED driver

540L28

MIDDLE POWER LED

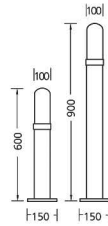

9ANK01

Ankraj / Anchorage



IP 44



540101



MAX.20W. TC-TSE E27

DAPHNE

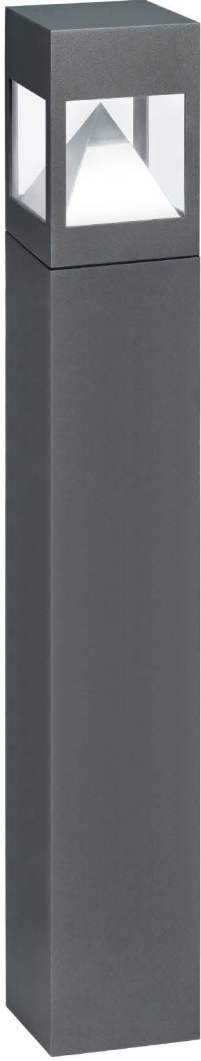

LED Tipi LED Type	Renk Isısı Color Temperature	Toplam Güç Total Power	Akım Current	Voltaj Voltage	Toplam Lümen Total Lumen
COB LED	3000K	16W	350mA	220V AC	1952lm
COB LED	4000K	16W	350mA	220V AC	2107lm

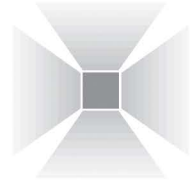

Malzeme : Alüminyum profil ve enjeksiyon gövde, alüminyum reflektör ve polikarbonat difüzör, galvanizli metal ankraj
Renk : Füme, Metalik Gri, Siyah
Armatürün yüzeyine elektrostatik toz boyadan önce korozyon direncini arttırıcı zincoprım uygulanır
LED sürücüsü dahil

Material : Die-cast aluminium and extruded body, aluminium reflector and polycarbonate diffuser, galvanized metal anchorage
Color : Graphite, Metallic Grey, Black
For corrosion resistance, zincoprım applied to surface of the luminaire before electrostatic powder coating
With LED driver

540L33

COB LED

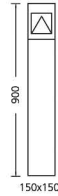

9ANK09

Ankraj / Anchorage



IP 65



FAGUS

LED Tipi LED Type	Renk Isısı Color Temperature	Toplam Güç Total Power	Akım Current	Voltaj Voltage	Toplam Lümen Total Lumen
Middle Power LED	3000K	22W	116mA	220V AC	1905lm
Middle Power LED	4000K	22W	116mA	220V AC	2087lm

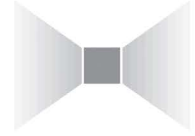

Malzeme : Alüminyum profil ve enjeksiyon gövde, akrilik difüzör, galvanizli metal ankraj

Renk : Füme, Metalik Gri, Siyah

Armatürün yüzeyine elektrostatik toz boyadan önce korozyon direncini arttırıcı zincoprım uygulanır
LED sürücüsü dahil

Material : Die-cast aluminium and extruded body, acrylic diffuser, galvanized metal anchorage

Color : Graphite, Metallic Grey, Black

For corrosion resistance, zincoprım applied to surface of the luminaire before electrostatic powder coating
With LED driver

540L30

MIDDLE POWER LED



9ANK10

Ankraj / Anchorage



IP 54



549148



MAX.36W. TC-L 2G11

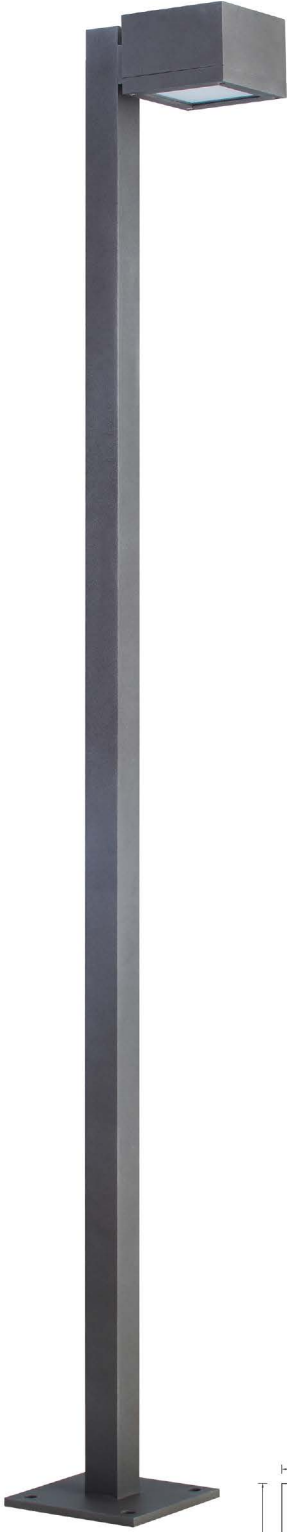

Sir Giyim - Sarnıç/ İZMİR

**540L31**

MIDDLE POWER LED

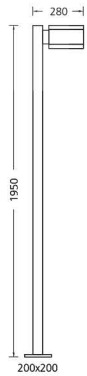

BETULA

LED Tipi LED Type	Renk Isısı Color Temperature	Toplam Güç Total Power	Akım Current	Voltaj Voltage	Toplam Lümen Total Lumen
Middle Power LED	3000K	16W	116mA	220V AC	1320lm
Middle Power LED	4000K	16W	116mA	220V AC	1460lm

Malzeme : Alüminyum profil ve enjeksiyon gövde, akrilik difüzör, galvanizli metal ankraj

Renk : Füme, Metalik Gri, Siyah

Armatürün yüzüne elektrostatik toz boyadan önce korozyon direncini artırıcı zincoprım uygulanır
LED sürücüsü dahil

Material : Die-cast aluminium and extruded body, acrylic diffuser, galvanized metal anchorage

Color : Graphite, Metallic Grey, Black

For corrosion resistance, zincoprım applied to surface of the luminaire before electrostatic powder coating
With LED driver

9ANK10

Ankraj / Anchorage



IP 65





**540L32**

MIDDLE POWER LED

NERIUM

LED Tipi LED Type	Renk Isısı Color Temperature	Toplam Güç Total Power	Akım Current	Voltaj Voltage	Toplam Lümen Total Lumen
Middle Power LED	3000K	16W	116mA	220V AC	1320lm
Middle Power LED	4000K	16W	116mA	220V AC	1460lm

Malzeme : Alüminyum profil ve enjeksiyon gövde, akrilik difüzör, galvanizli metal ankraj

Renk : Füme, Metalik Gri, Siyah

Armatürün yüzeyine elektrostatik toz boyadan önce korozyon direncini artırıcı zincoprım uygulanır
LED sürücüsü dahil

Material : Die-cast aluminium and extruded body, acrylic diffuser, galvanized metal anchorage

Color : Graphite, Metallic Grey, Black

For corrosion resistance, zincoprım applied to surface of the luminaire before electrostatic powder coating
With LED driver

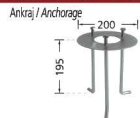
9ANK13

IP 65



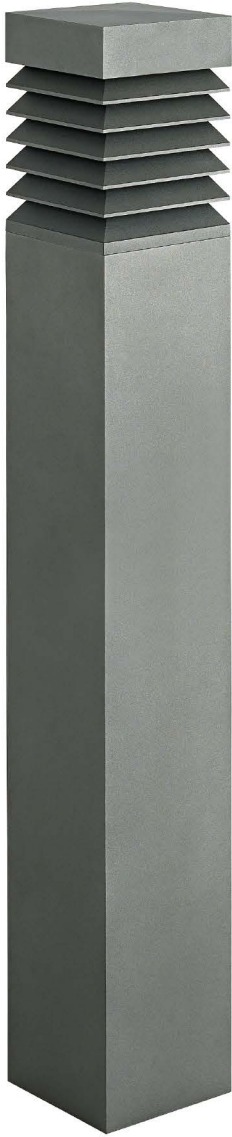

PHOENIX

LED Tipi LED Type	Renk Isısı Color Temperature	Toplam Güç Total Power	Akım Current	Voltaj Voltage	Toplam Lümen Total Lumen
Middle Power LED	3000K	26W	116mA	220V AC	2505lm
Middle Power LED	4000K	26W	116mA	220V AC	2603lm

Malzeme : Alüminyum profil ve enjeksiyon gövde, alüminyum reflektör ve akrilik difüzör,
galvanizli metal ankraj

Renk : Füme, Metalik Gri, Siyah
Armatürün yüzeyine elektrostatik toz boyadan önce korozyon direncini arttırıcı zincoprım uygulanır
LED sürücüsü dahil

Material : Die-cast aluminium and extruded body, aluminium reflector and acrylic diffuser,
galvanized metal anchorage

Color : Graphite, Metallic Grey, Black
For corrosion resistance, zincoprım applied to surface of the luminaire before electrostatic powder coating
With LED driver

540L34

MIDDLE POWER LED

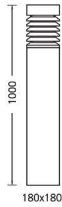

9ANK16

Ankraj / Anchorage



IP 65



549128



MAX.70W. HIT-CE G12



SEQUOIA

LED Tipi LED Type	Renk Isısı Color Temperature	Toplam Güç Total Power	Akım Current	Voltaj Voltage	Toplam Lümen Total Lumen
COB LED	3000K	8W	350mA	220V AC	669lm
COB LED	4000K	8W	350mA	220V AC	700lm

Malzeme : Alüminyum profil ve enjeksiyon gövde, akrilik difüzör, galvanizli metal ankraj

Renk : Füme, Metalik Gri, Siyah

Armatürün yüzeyine elektrostatik toz boyadan önce korozyon direncini arttırıcı zincoprım uygulanır
LED sürücüsü dahil

Material : Die-cast aluminium and extruded body, acrylic diffuser, galvanized metal anchorage

Color : Graphite, Metallic Grey, Black

For corrosion resistance, zincoprım applied to surface of the luminaire before electrostatic powder coating
With LED driver

540L36

COB LED



9ANK17

Ankraj / Anchorage



IP 54





LED Tipi LED Type	Renk Isısı Color Temperature	Toplam Güç Total Power	Akım Current	Voltaj Voltage	Toplam Lümen Total Lumen
Middle Power LED	3000K	22W	116mA	220V AC	1905lm
Middle Power LED	4000K	22W	116mA	220V AC	2087lm

Malzeme : Alüminyum profil ve enjeksiyon gövde, alüminyum reflektör ve akrilik difüzör
Renk : Füme, Metalik Gri, Siyah
Armatürün yüzeyine elektrostatik toz boyadan önce korozyon direncini artırıcı zincrim uygulanır.
LED sürücüsü dahil

Material : Die-cast aluminium and extruded body, aluminium reflector and acrylic diffuser
Color : Graphite, Metallic Grey, Black
For corrosion resistance, zincrim applied to surface of the luminaire before electrostatic powder coating
With LED driver

544L25

MIDDLE POWER LED

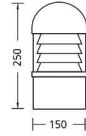

IP 65



541115



MAX.20W. TC-TSE E27



LED Tipi LED Type	Renk Isısı Color Temperature	Toplam Güç Total Power	Akım Current	Voltaj Voltage	Toplam Lümen Total Lumen
Middle Power LED	3000K	22W	116mA	220V AC	1905lm
Middle Power LED	4000K	22W	116mA	220V AC	2087lm

Malzeme : Alüminyum profil ve enjeksiyon gövde, akrilik difüzör
Renk : Füme, Metalik Gri, Siyah
Armatürün yüzeyine elektrostatik toz boyadan önce korozyon direncini artırıcı zincrim uygulanır.
LED sürücüsü dahil

Material : Die-cast aluminium and extruded body, acrylic diffuser
Color : Graphite, Metallic Grey, Black
For corrosion resistance, zincrim applied to surface of the luminaire before electrostatic powder coating
With LED driver

544L26

MIDDLE POWER LED

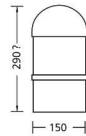

IP 65



541116



MAX.20W. TC-TSE E27



LED Tipi LED Type	Renk Isısı Color Temperature	Toplam Güç Total Power	Akım Current	Voltaj Voltage	Toplam Lümen Total Lumen
Middle Power LED	3000K	22W	116mA	220V AC	1905lm
Middle Power LED	4000K	22W	116mA	220V AC	2087lm

Malzeme : Alüminyum profil ve enjeksiyon gövde, alüminyum reflektör ve akrilik difüzör

Renk : Füme, Metalik Gri, Siyah

Armatürün yüzeyine elektrostatik toz boyadan önce korozyon direncini arttırıcı zincrim uygulanır.
LED sürücüsü dahil

Material : Die-cast aluminium and extruded body, aluminium reflector and acrylic diffuser

Color : Graphite, Metallic Grey, Black

For corrosion resistance, zincrim applied to surface of the luminaire before electrostatic powder coating
With LED driver

544L21

MIDDLE POWER LED

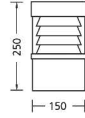

IP 65



541107



MAX.20W. TC-TSE E27



LED Tipi LED Type	Renk Isısı Color Temperature	Toplam Güç Total Power	Akım Current	Voltaj Voltage	Toplam Lümen Total Lumen
Middle Power LED	3000K	22W	116mA	220V AC	1905lm
Middle Power LED	4000K	22W	116mA	220V AC	2087lm

Malzeme : Alüminyum profil ve enjeksiyon gövde, akrilik difüzör

Renk : Füme, Metalik Gri, Siyah

Armatürün yüzeyine elektrostatik toz boyadan önce korozyon direncini arttırıcı zincrim uygulanır.
LED sürücüsü dahil

Material : Die-cast aluminium and extruded body, acrylic diffuser

Color : Graphite, Metallic Grey, Black

For corrosion resistance, zincrim applied to surface of the luminaire before electrostatic powder coating
With LED driver

544L24

MIDDLE POWER LED

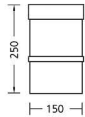

IP 65



541114



MAX.20W. TC-TSE E27





LED Tipi LED Type	Renk Isısı Color Temperature	Toplam Güç Total Power	Akım Current	Voltaj Voltage	Toplam Lümen Total Lumen
COB LED	3000K	16W	350mA	220V AC	1952lm
COB LED	4000K	16W	350mA	220V AC	2107lm

Malzeme : Alüminyum profil ve enjeksiyon gövde, akrilik difüzör

Renk : Füme, Metalik Gri, Siyah

Armatürün yüzeyine elektrostatik toz boyadan önce korozyon direncini artırıcı zincrim uygulanır.
LED sürücüsü dahil

Material : Die-cast aluminium and extruded body, acrylic diffuser

Color : Graphite, Metallic Grey, Black

For corrosion resistance, zincrim applied to surface of the luminaire before electrostatic powder coating
With LED driver

544L07

COB LED

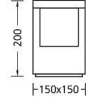

IP 65



541106



MAX.20W. TC-TSE E27



LED Tipi LED Type	Renk Isısı Color Temperature	Toplam Güç Total Power	Akım Current	Voltaj Voltage	Toplam Lümen Total Lumen
Middle Power LED	3000K	22W	116mA	220V AC	1905lm
Middle Power LED	4000K	22W	116mA	220V AC	2087lm

Malzeme : Alüminyum enjeksiyon gövde ve pres cam

Renk : Füme, Metalik Gri, Siyah

Armatürün yüzeyine elektrostatik toz boyadan önce korozyon direncini artırıcı zincrim uygulanır.
LED sürücüsü dahil

Material : Die-cast aluminium body and pressed glass

Color : Graphite, Metallic Grey, Black

For corrosion resistance, zincrim applied to surface of the luminaire before electrostatic powder coating
With LED driver

544L08

MIDDLE POWER LED

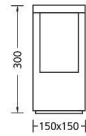

IP 65



541109



MAX.18W. TC-L 2G11

541113



MAX.20W. TC-TSE E27



LED Tipi LED Type	Renk Isısı Color Temperature	Toplam Güç Total Power	Akım Current	Voltaj Voltage	Toplam Lümen Total Lumen
Middle Power LED	3000K	22W	116mA	220V AC	1905lm
Middle Power LED	4000K	22W	116mA	220V AC	2087lm

Malzeme : Alüminyum profil ve enjeksiyon gövde, alüminyum reflektör ve akrilik difüzör
Renk : Füme, Metalik Gri, Siyah
 Armatürün yüzeyine elektrostatik toz boyadan önce korozyon direncini arttırıcı zincrim uygulanır.
 LED sürücüsü dahil

Material : Die-cast aluminium and extruded body, aluminium reflector and acrylic diffuser
Color : Graphite, Metallic Grey, Black
 For corrosion resistance, zincrim applied to surface of the luminaire before electrostatic powder coating
 With LED driver

544L27

MIDDLE POWER LED

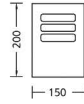

IP 65



541108



MAX.20W. TC-T5E E27



LED Tipi LED Type	Renk Isısı Color Temperature	Toplam Güç Total Power	Akım Current	Voltaj Voltage	Toplam Lümen Total Lumen
Middle Power LED	3000K	16W	350mA	220V AC	1952lm
Middle Power LED	4000K	16W	350mA	220V AC	2107lm

Malzeme : Alüminyum profil ve enjeksiyon gövde, akrilik difüzör
Renk : Füme, Metalik Gri, Siyah
 Armatürün yüzeyine elektrostatik toz boyadan önce korozyon direncini arttırıcı zincrim uygulanır.
 LED sürücüsü dahil

Material : Die-cast aluminium and extruded body, acrylic diffuser
Color : Graphite, Metallic Grey, Black
 For corrosion resistance, zincrim applied to surface of the luminaire before electrostatic powder coating
 With LED driver

544L28

COB LED

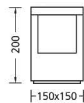

IP 65



541114



MAX.20W. TC-T5E E27

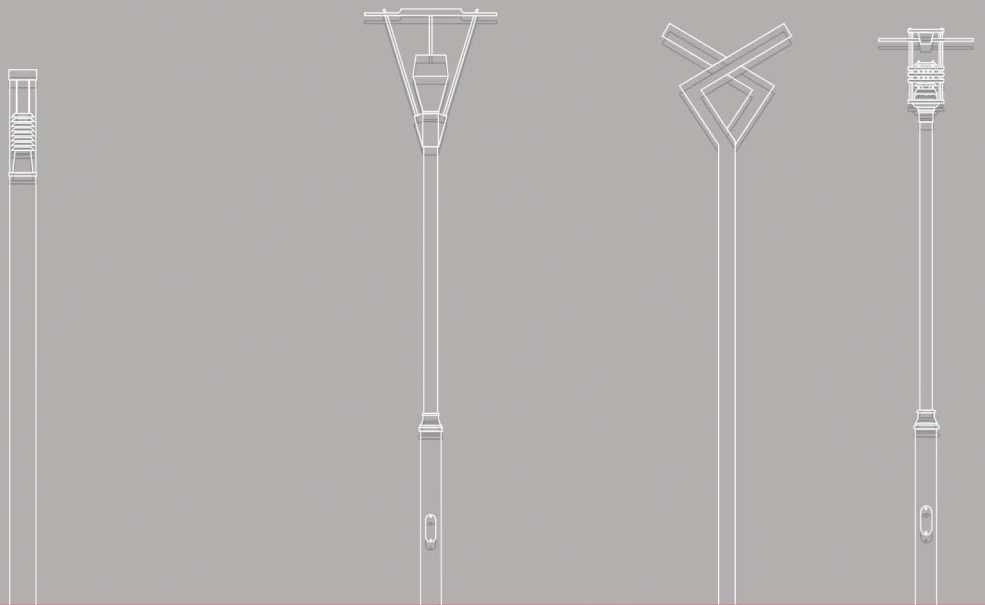

STILAS

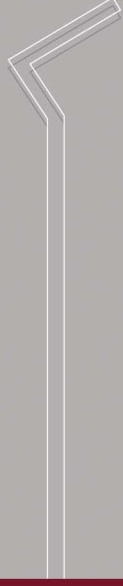

Dış Aydınlatma Armatürleri | Exterior Luminaires



Aydınlatma Direkleri Pole-Top Luminaires

ABIES

Malzeme : Alüminyum profil ve enjeksiyon gövde, akrilik difüzör, galvanizli metal ankraj

Renk : Füme, Metalik Gri, Siyah

Armatürün yüzeyine elektrostatik toz boyadan önce korozyon direncini artırıcı zincoprım uygulanır
LED sürücüsü dahil

Material : Die-cast aluminium and extruded body, acrylic diffuser, galvanized metal anchorage

Color : Graphite, Metallic Grey, Black

For corrosion resistance, zincoprım applied to surface of the luminaire before electrostatic powder coating
With LED driver

LED Tipi LED Type	Renk Isısı Color Temperature	Toplam Güç Total Power	Akım Current	Voltaj Voltage	Toplam Lümen Total Lumen
Middle Power LED	3000K	51W	116mA	220V AC	5010lm
Middle Power LED	4000K	51W	116mA	220V AC	5205lm

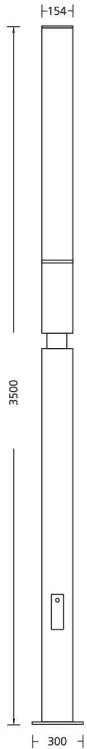

549L01

MIDDLE POWER LED

9ANK05

Ankraj / Anchorage



IP 65



549209



MAX.2x54W. T16 G5



GINEPRO

Malzeme : Alüminyum profil ve enjeksiyon gövde, ısıya dayanıklı cam, galvanizli metal ankraj

Renk : Füme, Metalik Gri, Siyah

Armatürün yüzeyine elektrostatik toz boyadan önce korozyon direncini artırıcı zincoprım uygulanır
LED sürücüsü dahil

Material : Die-cast aluminium and extruded body, tempered glass, galvanized metal anchorage

Color : Graphite, Metallic Grey, Black

For corrosion resistance, zincoprım applied to surface of the luminaire before electrostatic powder coating
With LED driver

LED Tipi LED Type	Renk Isısı Color Temperature	Toplam Güç Total Power	Akım Current	Voltaj Voltage	Toplam Lümen Total Lumen
COB LED	3000K	21W	500mA	220V AC	2260lm
COB LED	4000K	21W	500mA	220V AC	2456lm
COB LED	6000K	21W	500mA	220V AC	2456lm

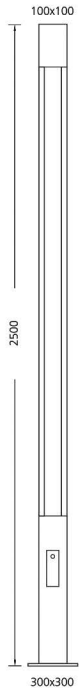

549L02

COB LED

9ANK11

Ankraj / Anchorage



IP 65



MELIA

Malzeme : Alüminyum profil ve enjeksiyon gövde, akrilik difüzör, galvanizli metal ankraj
Renk : Füme, Metalik Gri, Siyah
Armatürün yüzeyine elektrostatik toz boyadan önce korozyon direncini artırıcı zincoprım uygulanır
LED sürücüsü dahil

Material : Die-cast aluminium and extruded body, acrylic diffuser, galvanized metal anchorage
Color : Graphite, Metallic Grey, Black
For corrosion resistance, zincoprım applied to surface of the luminaire before electrostatic powder coating
With LED driver

LED Tipi LED Type	Renk Isısı Color Temperature	Toplam Güç Total Power	Akım Current	Voltaj Voltage	Toplam Lümen Total Lumen
Middle Power LED	3000K	44W	116mA	220V AC	3810lm
Middle Power LED	4000K	44W	116mA	220V AC	4174lm

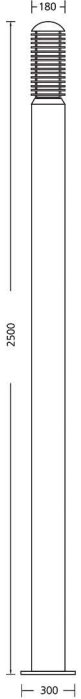

549L04

MIDDLE POWER LED

9ANK05

Ankraj / Anchorage



IP 65





MYSIA

Malzeme : Alüminyum profil ve enjeksiyon gövde, alüminyum reflektör ve polikarbonat difüzör, galvanizli metal ankraj
 Renk : Füme, Metalik Gri, Siyah
 Armatürün yüzeyine elektrostatik toz boyadan önce korozyon direncini arttırıcı zincoprim uygulanır. LED sürücüsü dahil

Material : Die-cast aluminium and extruded body, aluminium reflector and polycarbonate diffuser, galvanized metal anchorage
 Color : Graphite, Metallic Grey, Black
 For corrosion resistance, zincoprim applied to surface of the luminaire before electrostatic powder coating. With LED driver

LED Tipi LED Type	Renk Isısı Color Temperature	Toplam Güç Total Power	Akım Current	Voltaj Voltage	Toplam Lümen Total Lumen
Middle Power LED	3000K	44W	116mA	220V AC	3810lm
Middle Power LED	4000K	44W	116mA	220V AC	4174lm

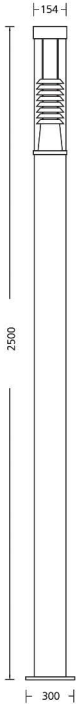

549L03

MIDDLE POWER LED

9ANK05

Ankraj / Anchorage



IP 65



549206



MAX.2x24W. TC-L 2G11



Şehir Parkı - BURSA

FAGUS

Malzeme : Alüminyum profil ve enjeksiyon gövde, alüminyum reflektör ve akrilik difüzör,
galvanizli metal ankraj
Renk : Füme, Metalik Gri, Siyah
Armatürün yüzeyine elektrostatik toz boyadan önce korozyon direncini arttırıcı zincoprım uygulanır
LED sürücüsü dahil

Material : Die-cast aluminium and extruded body, aluminium reflector and acrylic diffuser,
galvanized metal anchorage
Color : Graphite, Metallic Grey, Black
For corrosion resistance, zincoprım applied to surface of the luminaire before electrostatic powder coating
With LED driver

LED Tipi LED Type	Renk Isısı Color Temperature	Toplam Güç Total Power	Akım Current	Voltaj Voltage	Toplam Lümen Total Lumen
Middle Power LED	3000K	51W	116mA	220V AC	5010lm
Middle Power LED	4000K	51W	116mA	220V AC	5205lm

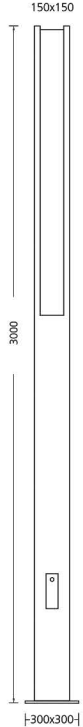

549L05

9ANK14

MIDDLE POWER LED

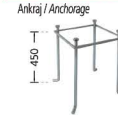

IP 65



549210



MAX.2x58W, T16 G5



Yüksek Teknoloji Enstitüsü - Urla/ İZMİR

GINEPRO

Malzeme : Alüminyum profil ve enjeksiyon gövde, ısıya dayanıklı cam, galvanizli metal ankraj

Renk : Füme, Metalik Gri, Siyah

Armatürün yüzeyine elektrostatik toz boyadan önce korozyon direncini artırıcı zincoprım uygulanır
LED sürücüsü dahil

Material : Die-cast aluminium and extruded body, tempered glass, galvanized metal anchorage

Color : Graphite, Metallic Grey, Black

For corrosion resistance, zincoprım applied to surface of the luminaire before electrostatic powder coating
With LED driver

LED Tipi LED Type	Renk Isısı Color Temperature	Toplam Güç Total Power	Akım Current	Voltaj Voltage	Toplam Lümen Total Lumen
COB LED	3000K	38W	1050mA	220V AC	4094lm
COB LED	4000K	38W	1050mA	220V AC	4341lm
COB LED	5000K	38W	1050mA	220V AC	4429lm

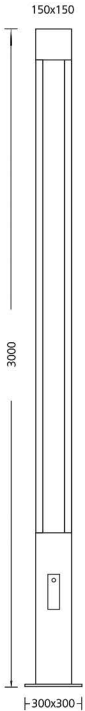

549L06

COB LED

9ANK14

Ankraj / Anchorage



IP 65





Turkuaz AVM - BURSA

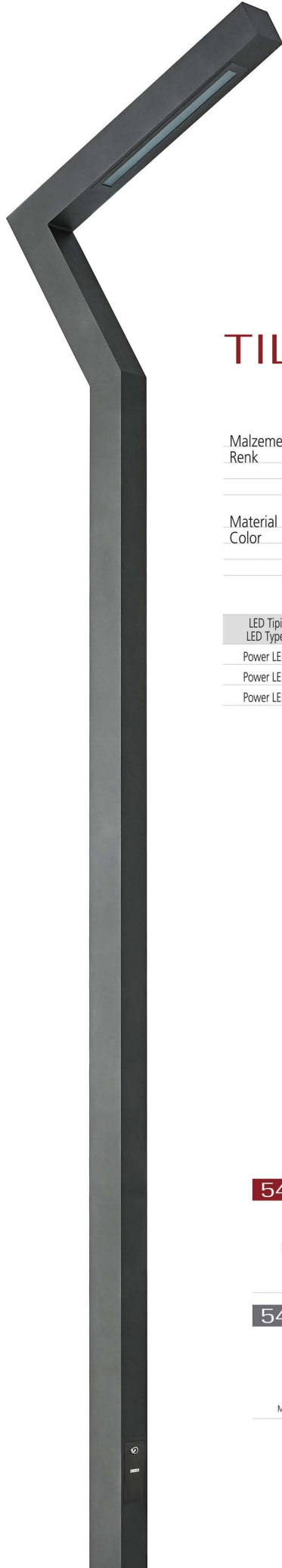

TILIA

Malzeme : Alüminyum profil ve enjeksiyon gövde, akrilik difüzör, galvanizli metal ankraj

Renk : Füme, Metalik Gri, Siyah

Armatürün yüzeyine elektrostatik toz boyadan önce korozyon direncini arttırıcı zincoprım uygulanır.
LED sürücüsü dahil

Material : Die-cast aluminium and extruded body, acrylic diffuser, galvanized metal anchorage

Color : Graphite, Metallic Grey, Black

For corrosion resistance, zincoprım applied to surface of the luminaire before electrostatic powder coating
With LED driver

LED Tipi LED Type	Renk Isısı Color Temperature	Toplam Güç Total Power	Akım Current	Voltaj Voltage	Toplam Lümen Total Lumen
Power LED	3000K	54W	700mA	220V AC	4916lm
Power LED	4000K	54W	700mA	220V AC	5520lm
Power LED	6500K	54W	700mA	220V AC	6134lm

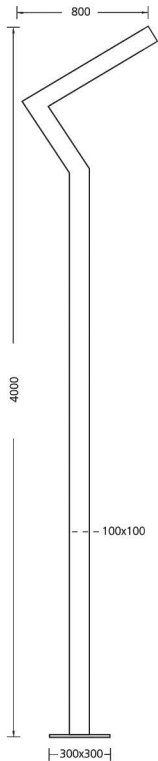

549L08

POWER LED

9ANK14

Ankraj / Anchorage



IP 65



549140



MAX.55W. TC-L 2G11



LA Mahzen Restaurant - Torbalı / İZMİR

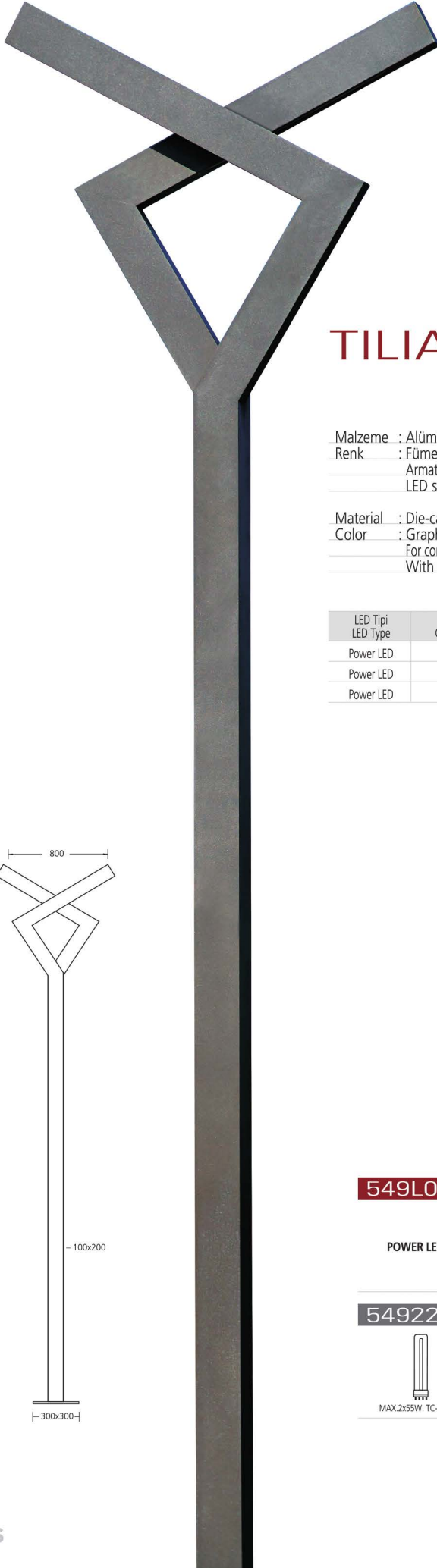

TILIA

Malzeme : Alüminyum profil ve enjeksiyon gövde, akrilik difüzör, galvanizli metal ankraj

Renk : Füme, Metalik Gri, Siyah

Armatürün yüzeyine elektrostatik toz boyadan önce korozyon direncini arttırıcı zincoprım uygulanır.
LED sürücüsü dahil

Material : Die-cast aluminium and extruded body, acrylic diffuser, galvanized metal anchorage

Color : Graphite, Metallic Grey, Black

For corrosion resistance, zincoprım applied to surface of the luminaire before electrostatic powder coating
With LED driver

LED Tipi LED Type	Renk Isısı Color Temperature	Toplam Güç Total Power	Akım Current	Voltaj Voltage	Toplam Lümen Total Lumen
Power LED	3000K	2x54W	700mA	220V AC	2x4916lm
Power LED	4000K	2x54W	700mA	220V AC	2x5520lm
Power LED	6500K	2x54W	700mA	220V AC	2x6134lm

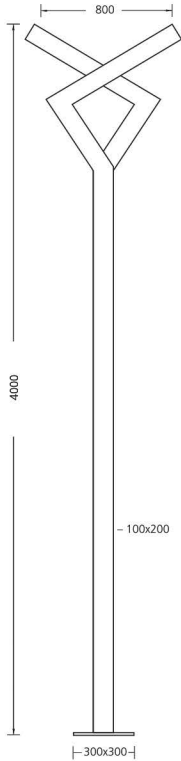

549L09

POWER LED

9ANK14

Ankraj / Anchorage



IP 65



549223



MAX.2x55W. TC-L 2G11



LA Mahzen Restaurant - Torbalı / İZMİR

CARPINUS

Malzeme : Alüminyum profil ve enjeksiyon gövde, akrilik difüzör, galvanizli metal ankraj

Renk : Füme, Metalik Gri, Siyah

Armatürün yüzeyine elektrostatik toz boyadan önce korozyon direncini artırıcı zincoprım uygulanır.
LED sürücüsü dahil

Material : Die-cast aluminium and extruded body, acrylic diffuser, galvanized metal anchorage

Color : Graphite, Metallic Grey, Black

For corrosion resistance, zincoprım applied to surface of the luminaire before electrostatic powder coating
With LED driver

LED Tipi LED Type	Renk Isısı Color Temperature	Toplam Güç Total Power	Akım Current	Voltaj Voltage	Toplam Lümen Total Lumen
Power LED	3000K	54W	700mA	220V AC	4916lm
Power LED	4000K	54W	700mA	220V AC	5520lm
Power LED	6500K	54W	700mA	220V AC	6134lm

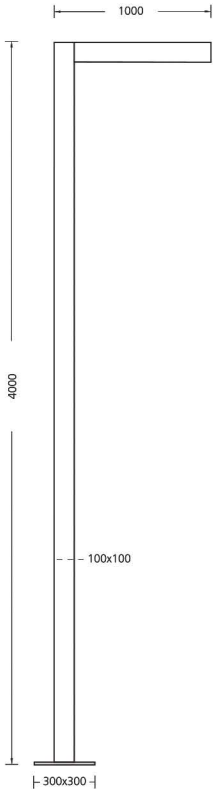
**549L10**

POWER LED

9ANK14

Ankraj / Anchorage



IP 65

**549141**

MAX.55W. TC-L 2G11



Teleferik - Balçova/ İZMİR

CARPINUS

Malzeme : Alüminyum profil ve enjeksiyon gövde, alüminyum reflektör ve akrilik difüzör,
galvanizli metal ankraj
Renk : Füme, Metalik Gri, Siyah
Armatürün yüzeyine elektrostatik toz boyadan önce korozyon direncini artırıcı zincoprım uygulanır.
LED sürücüsü dahil

Material : Die-cast aluminium and extruded body, aluminium reflector and acrylic diffuser,
galvanized metal anchorage
Color : Graphite, Metallic Grey, Black
For corrosion resistance, zincoprım applied to surface of the luminaire before electrostatic powder coating
With LED driver

LED Tipi LED Type	Renk Sısı Color Temperature	Toplam Güç Total Power	Akım Current	Voltaj Voltage	Toplam Lümen Total Lumen
Power LED	3000K	2x54W	700mA	220V AC	2x4916lm
Power LED	4000K	2x54W	700mA	220V AC	2x5520lm
Power LED	6500K	2x54W	700mA	220V AC	2x6134lm

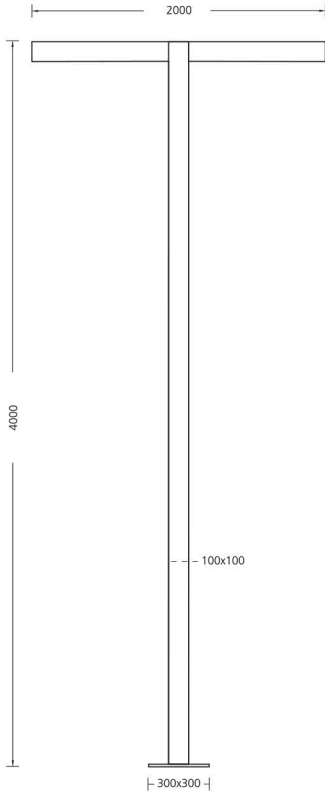

549L11

POWER LED

9ANK14

Ankraj / Anchorage



IP 65



549220



MAX.55W. TC-L 2G11

CEDRUS

Malzeme : Alüminyum profil ve enjeksiyon gövde, alüminyum reflektör ve akrilik difüzör,
galvanizli metal ankraj
Renk : Füme, Metalik Gri, Siyah
Armatürün yüzeyine elektrostatik toz boyadan önce korozyon direncini arttırıcı zincoprim uygulanır
LED sürücüsü dahil

Material : Die-cast aluminium and extruded body, aluminium reflector and acrylic diffuser,
galvanized metal anchorage
Color : Graphite, Metallic Grey, Black
For corrosion resistance, zincoprim applied to surface of the luminaire before electrostatic powder coating
With LED driver

LED Tipi LED Type	Renk Isısı Color Temperature	Toplam Güç Total Power	Akım Current	Voltaj Voltage	Toplam Lümen Total Lumen
Middle Power LED	3000K	51W	116mA	220V AC	5010lm
Middle Power LED	4000K	51W	116mA	220V AC	5205lm



549L07

MIDDLE POWER LED

9ANK14

Ankraj / Anchorage



IP 65



549211



MAX.2xS8W, T16 G5

SALICE

Malzeme : Alüminyum profil ve enjeksiyon gövde, akrilik difüzör, galvanizli metal ankraj

Renk : Füme, Metalik Gri, Siyah

Armatürün yüzeyine elektrostatik toz boyadan önce korozyon direncini artırıcı zincoprım uygulanır
LED sürücüsü dahil

Material : Die-cast aluminium and extruded body, acrylic diffuser, galvanized metal anchorage

Color : Graphite, Metallic Grey, Black

For corrosion resistance, zincoprım applied to surface of the luminaire before electrostatic powder coating
With LED driver

LED Tipi LED Type	Renk Isısı Color Temperature	Toplam Güç Total Power	Akım Current	Voltaj Voltage	Toplam Lümen Total Lumen
Middle Power LED	3000K	51W	116mA	220V AC	5010lm
Middle Power LED	4000K	51W	116mA	220V AC	5205lm

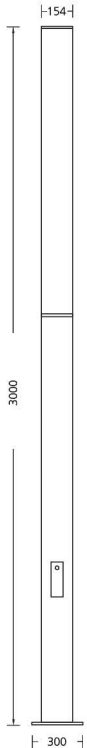

549L13

9ANK05

MIDDLE POWER LED



IP 54



549207



MAX.2x49W, T16 G5

GINEPRO

Malzeme : Alüminyum profil ve enjeksiyon gövde, ısıya dayanıklı cam, galvanizli metal ankraj
Renk : Füme, Metalik Gri, Siyah
Armatürün yüzeyine elektrostatik toz boyadan önce korozyon direncini artırıcı zincoprım uygulanır
LED sürücüsü dahil

Material : Die-cast aluminium and extruded body, tempered glass, galvanized metal anchorage
Color : Graphite, Metallic Grey, Black
For corrosion resistance, zincoprım applied to surface of the luminaire before electrostatic powder coating
With LED driver

LED Tipi LED Type	Renk Isısı Color Temperature	Toplam Güç Total Power	Akım Current	Voltaj Voltage	Toplam Lümen Total Lumen
COB LED	3000K	48W	1050mA	220V AC	4350lm
COB LED	4000K	48W	1050mA	220V AC	5155lm
COB LED	6000K	48W	1050mA	220V AC	5155lm

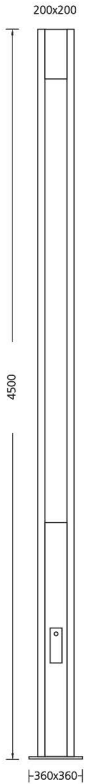

549L12

POWER LED

9ANK14

Ankraj / Anchorage



IP 65



549139



MAX.70W.-150W. HIT-CE G12



Turkuaz AVM - BURSA



Kasaplar Meydanı - Buca/ İZMİR



MITRA

Malzeme : Alüminyum profil ve enjeksiyon gövde, akrilik difüzör, galvanizli metal ankraj
 Renk : Füme, Metalik Gri, Siyah
 Armatürün yüzeyine elektrostatik toz boyadan önce korozyon direncini artırıcı zincoprım uygulanır.
 LED sürücüsü dahil

Material : Die-cast aluminium and extruded body, acrylic diffuser, galvanized metal anchorage
 Color : Graphite, Metallic Grey, Black
 For corrosion resistance, zincoprım applied to surface of the luminaire before electrostatic powder coating
 With LED driver

LED Tipi LED Type	Renk Isısı Color Temperature	Toplam Güç Total Power	Akım Current	Voltaj Voltage	Toplam Lümen Total Lumen
Power LED	3000K	82W	700mA	220V AC	7374lm
Power LED	4000K	82W	700mA	220V AC	8280lm
Power LED	6500K	82W	700mA	220V AC	9261lm

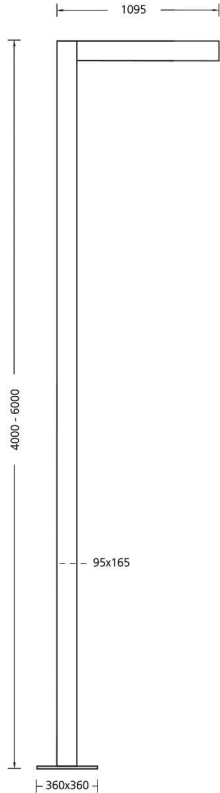

549L15

9ANK14

POWER LED

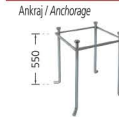

IP 65



549136



MAX.80W. TC-L 2G11



Teleferik - Balçova/ İZMİR

MITRA

Malzeme : Alüminyum profil ve enjeksiyon gövde, akrilik difüzör, galvanizli metal ankraj
 Renk : Füme, Metalik Gri, Siyah
 Armatürün yüzeyine elektrostatik toz boyadan önce korozyon direncini artırıcı zincoprım uygulanır.
 LED sürücüsü dahil

Material : Die-cast aluminium and extruded body, acrylic diffuser, galvanized metal anchorage
 Color : Graphite, Metallic Grey, Black
 For corrosion resistance, zincoprım applied to surface of the luminaire before electrostatic powder coating
 With LED driver

LED Tipi LED Type	Renk Isısı Color Temperature	Toplam Güç Total Power	Akım Current	Voltaj Voltage	Toplam Lümen Total Lumen
Power LED	3000K	2x82W	700mA	220V AC	2x7374lm
Power LED	4000K	2x82W	700mA	220V AC	2x8280lm
Power LED	6500K	2x82W	700mA	220V AC	2x9261lm

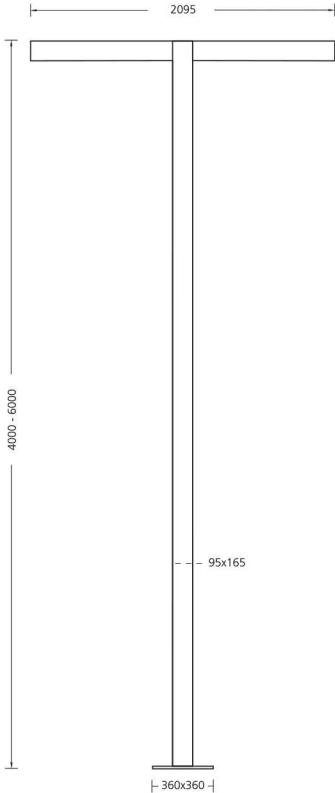

549L16

POWER LED

9ANK14

Ankraj / Anchorage



IP 65



549215



MAX.2x80W. TC-L 2G11

MITRA

Malzeme : Alüminyum profil ve enjeksiyon gövde, akrilik difüzör, galvanizli metal ankraj
Renk : Füme, Metalik Gri, Siyah
Armatürün yüzeyine elektrostatik toz boyadan önce korozyon direncini artırıcı zincoprım uygulanır.
LED sürücüsü dahil

Material : Die-cast aluminium and extruded body, acrylic diffuser, galvanized metal anchorage
Color : Graphite, Metallic Grey, Black
For corrosion resistance, zincoprım applied to surface of the luminaire before electrostatic powder coating
With LED driver

LED Tipi LED Type	Renk Isısı Color Temperature	Toplam Güç Total Power	Akım Current	Voltaj Voltage	Toplam Lümen Total Lumen
Power LED	3000K	2x82W	700mA	220V AC	2x7374lm
Power LED	4000K	2x82W	700mA	220V AC	2x8280lm
Power LED	6500K	2x82W	700mA	220V AC	2x9261lm

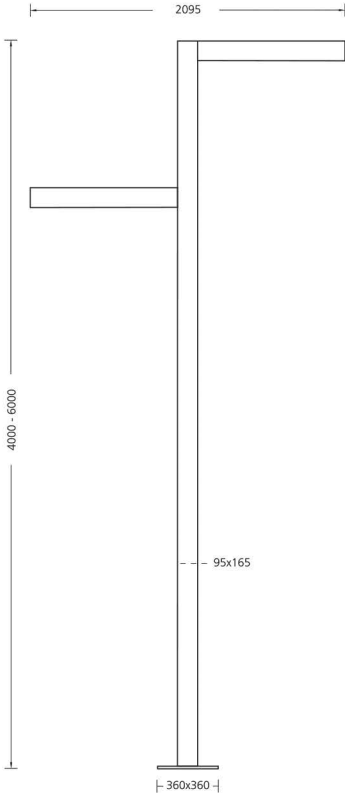

549L17

POWER LED

9ANK14

Ankraj / Anchorage



IP 65



549224



MAX.2x80W. TC-L 2G11



LYDIA

Malzeme : Alüminyum üst başlık, ısıya dayanıklı cam ve çelik boru direk gövdesi,
galvanizli metal ankrāj

Renk : Fūme, Metalik Gri, Siyah
Armatürün yüzeyine elektrostatik toz boyadan önce korozyon direncini artırıcı zincoprīm uygulanır.
LED sürücüsü dahil

Material : Aluminium head, tempered glass and pole body made of steel tube,
galvanized metal anchorage

Color : Graphite, Metallic Grey, Black
For corrosion resistance, zincoprīm applied to surface of the luminaire before electrostatic powder coating
With LED driver

LED Tipi LED Type	Renk Isısı Color Temperature	Toplam Güç Total Power	Akım Current	Voltaj Voltage	Toplam Lümen Total Lumen
Power LED	3000K	54W	700mA	220V AC	4916lm
Power LED	4000K	54W	700mA	220V AC	5520lm
Power LED	6500K	54W	700mA	220V AC	6134lm

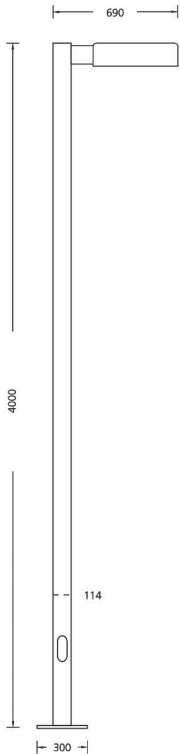

549L18

9ANK05

POWER LED



IP 65



549108



MAX.70W.-150W. HIT-CE G12



Süleyman Seba Villaları - Bodrum/ MUĞLA



LYDIA

Malzeme : Alüminyum üst başlık, ısıya dayanıklı cam ve çelik boru direk gövdesi,
galvanizli metal ankraj

Renk : Füme, Metalik Gri, Siyah

Armatürün yüzeyine elektrostatik toz boyadan önce korozyon direncini artırıcı zincoprım uygulanır.
LED sürücüsü dahil

Material : Aluminium head, tempered glass and pole body made of steel tube,
galvanized metal anchorage

Color : Graphite, Metallic Grey, Black

For corrosion resistance, zincoprım applied to surface of the luminaire before electrostatic powder coating
With LED driver

LED Tipi LED Type	Renk Sısı Color Temperature	Toplam Güç Total Power	Akım Current	Voltaj Voltage	Toplam Lümen Total Lumen
Power LED	3000K	2x54W	700mA	220V AC	2x4916lm
Power LED	4000K	2x54W	700mA	220V AC	2x5520lm
Power LED	6500K	2x54W	700mA	220V AC	2x6134lm

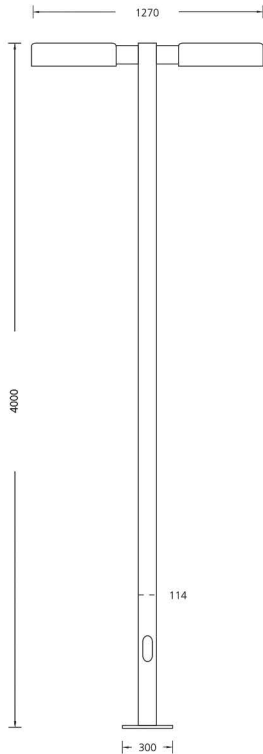

549L19

POWER LED

9ANK05

Ankraj / Anchorage



IP 65



549224



MAX.2x70W.-150W. HIT-CE G12

CELTIS

Malzeme : Alüminyum profil ve enjeksiyon gövde, akrilik difüzör, galvanizli metal ankraj
Renk : Füme, Metalik Gri, Siyah
Armatürün yüzeyine elektrostatik toz boyadan önce korozyon direncini artırıcı zincoprım uygulanır
LED sürücüsü dahil

Material : Die-cast aluminium and extruded body, acrylic diffuser, galvanized metal anchorage
Color : Graphite, Metallic Grey, Black
For corrosion resistance, zincoprım applied to surface of the luminaire before electrostatic powder coating
With LED driver

LED Tipi LED Type	Renk Isısı Color Temperature	Toplam Güç Total Power	Akım Current	Voltaj Voltage	Toplam Lümen Total Lumen
Middle Power LED	3000K	25W	116mA	220V AC	2505lm
Middle Power LED	4000K	25W	116mA	220V AC	2603lm

LED Tipi LED Type	Renk Isısı Color Temperature	Toplam Güç Total Power	Akım Current	Voltaj Voltage	Toplam Lümen Total Lumen
Middle Power LED	R - 620nm	15W	116mA	220V AC	1080lm
Middle Power LED	G - 525nm	15W	116mA	220V AC	1560lm
Middle Power LED	B - 470nm	15W	116mA	220V AC	600lm

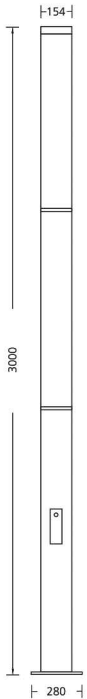

549L14

MIDDLE POWER LED

9ANK05

Ankraj / Anchorage



IP 54





HEDERA

Malzeme : Polimer üst başlık ve alüminyum iç reflektör, alüminyum indirek üst yansıtıcı ve çelik boru direk gövdesi, galvanizli metal ankraj

Renk : Füme, Metalik Gri, Siyah

Armatürün yüzeyine elektrostatik toz boyadan önce korozyon direncini artırıcı zincoprım uygulanır. LED sürücüsü dahil

Material : Polimer upper head and aluminium inner reflector, aluminium indirect upper reflector and pole body made of steel tube, galvanized metal anchorage

Color : Graphite, Metallic Grey, Black

For corrosion resistance, zincoprım applied to surface of the luminaire before electrostatic powder coating. With LED driver

LED Tipi LED Type	Renk Isısı Color Temperature	Toplam Güç Total Power	Akım Current	Voltaj Voltage	Toplam Lümen Total Lumen
Power LED	3000K	45W	700mA	220V AC	3687lm
Power LED	4000K	45W	700mA	220V AC	4140lm
Power LED	6500K	45W	700mA	220V AC	4630lm

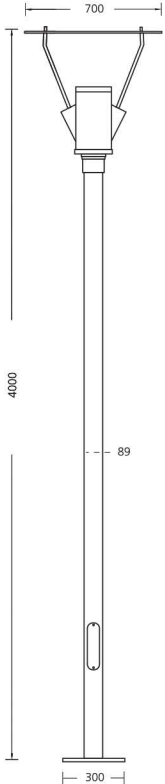

549L20

9ANK05

POWER LED



IP 65



549132



MAX.70W.-150W. HIT-CE G12

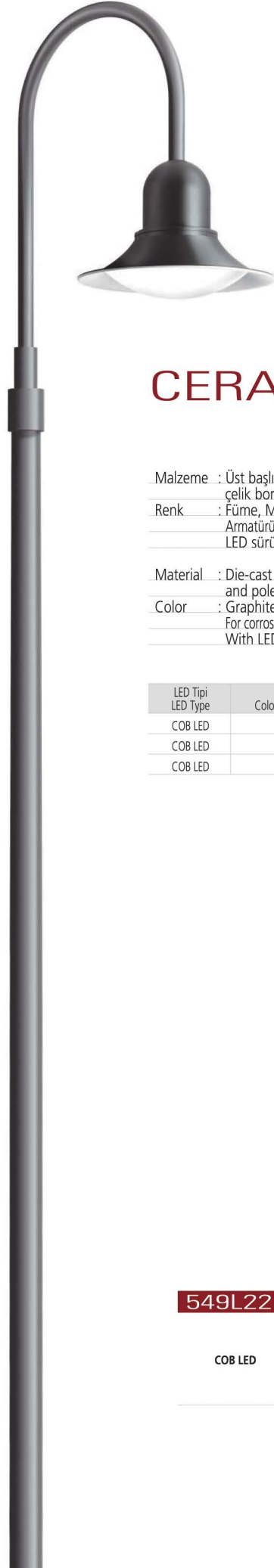

CERASIS

Malzeme : Üst başlık alüminyum enjeksiyon ve polikarbonat difüzör, alüminyum iç reflektör ve çelik boru direk gövdesi, galvanizli metal ankraj
 Renk : Füme, Metalik Gri, Siyah
 Armatürün yüzeyine elektrostatik toz boyadan önce korozyon direncini artırıcı zincoprım uygulanır LED sürücüsü dahil

Material : Die-cast aluminium and polycarbonate diffuser upper head, aluminium inner reflector and pole body made of steel tube, galvanized metal anchorage
 Color : Graphite, Metallic Grey, Black
 For corrosion resistance, zincoprım applied to surface of the luminaire before electrostatic powder coating With LED driver

LED Tipi LED Type	Renk Isısı Color Temperature	Toplam Güç Total Power	Akım Current	Voltaj Voltage	Toplam Lümen Total Lumen
COB LED	3000K	38W	1050mA	220V AC	4094lm
COB LED	4000K	38W	1050mA	220V AC	4341lm
COB LED	6000K	38W	1050mA	220V AC	4429lm

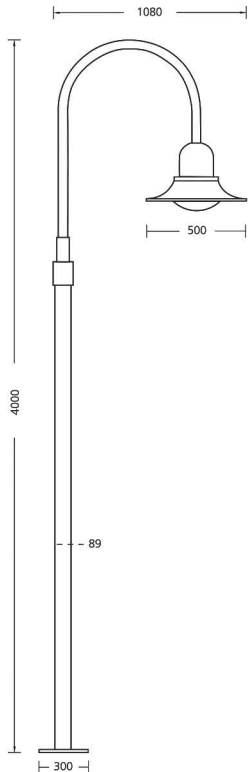

549L22

COB LED

9ANK05

Ankraj / Anchorage



IP 65



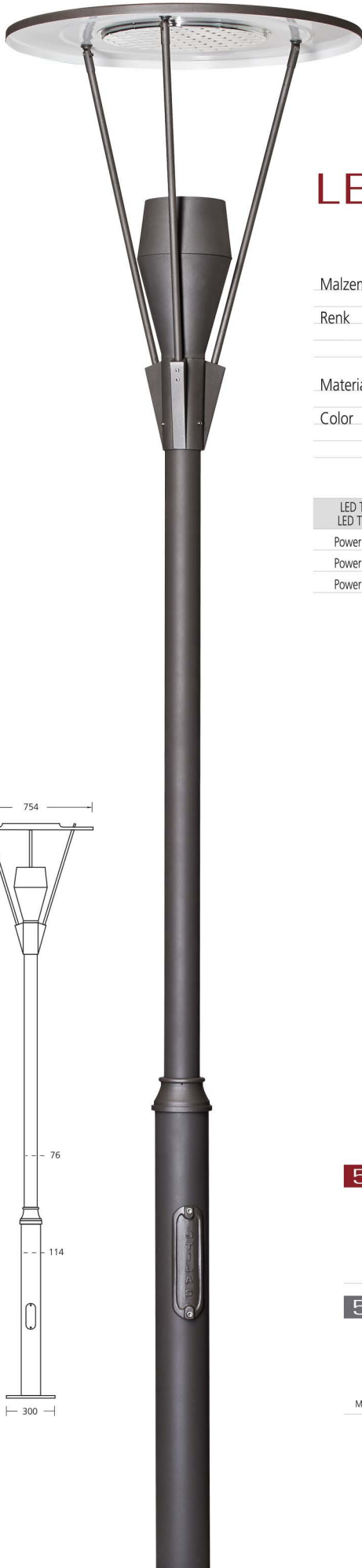

LETO

Malzeme : Polimer üst başlık ve alüminyum iç reflektör, alüminyum indirek üst yansıtıcı ve çelik boru direk gövdesi, galvanizli metal ankraj

Renk : Füme, Metalik Gri, Siyah

Armatürün yüzeyine elektrostatik toz boyadan önce korozyon direncini artırıcı zincoprım uygulanır. LED sürücüsü dahil

Material : Polimer upper head and aluminium inner reflector, aluminium indirect upper reflector and pole body made of steel tube, galvanized metal anchorage

Color : Graphite, Metallic Grey, Black

For corrosion resistance, zincoprım applied to surface of the luminaire before electrostatic powder coating With LED driver

LED Tipi LED Type	Renk Isısı Color Temperature	Toplam Güç Total Power	Akım Current	Voltaj Voltage	Toplam Lümen Total Lumen
Power LED	3000K	45W	700mA	220V AC	3687lm
Power LED	4000K	45W	700mA	220V AC	4140lm
Power LED	6500K	45W	700mA	220V AC	4630lm

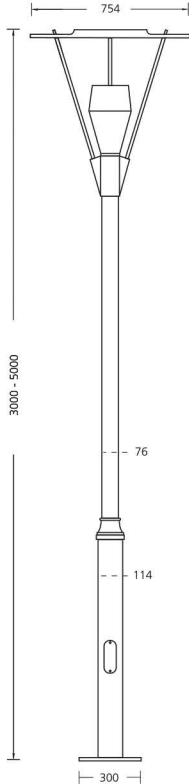

549L21

9ANK05

POWER LED



IP 65



549104



MAX.70W.-150W. HIT-CE G12



Yaşar Üniversitesi - İZMİR



DOR

Malzeme : Üst başlık alüminyum enjeksiyon ve polikarbonat difüzör, alüminyum iç reflektör ve çelik boru direk gövdesi, galvanizli metal ankraj

Renk : Füme, Metalik Gri, Siyah

Armatürün yüzeyine elektrostatik toz boyadan önce korozyon direncini artırıcı zincoprım uygulanır. LED sürücüsü dahil

Material : Die-cast aluminium and pycarbonate diffuser upper head, aluminium inner reflector and pole body made of steel tube, galvanized metal anchorage

Color : Graphite, Metallic Grey, Black

For corrosion resistance, zincoprım applied to surface of the luminaire before electrostatic powder coating. With LED driver

LED Tipi LED Type	Renk Isısı Color Temperature	Toplam Güç Total Power	Akım Current	Voltaj Voltage	Toplam Lümen Total Lumen
Middle Power LED	3000K	44W	116mA	220V AC	3810lm
Middle Power LED	4000K	44W	116mA	220V AC	4174lm

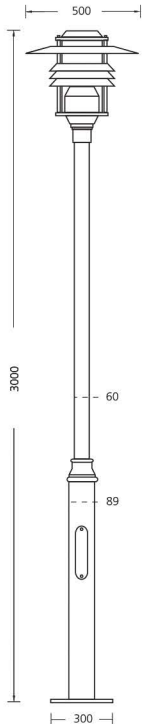

549L23

9ANK05

MIDDLE POWER LED



IP 65



549212



MAX.2x24W. TC-L 2G11



KORINT

Malzeme : Üst başlık alüminyum enjeksiyon ve polikarbonat difüzör, alüminyum iç reflektör ve çelik boru direk gövdesi, galvanizli metal ankraj

Renk : Füme, Metalik Gri, Siyah
Armatürün yüzeyine elektrostatik toz boyadan önce korozyon direncini artırıcı zincrim uygulanır. LED sürücüsü dahil

Material : Die-cast aluminium and polycarbonate diffuser upper head, aluminium inner reflector and pole body made of steel tube, galvanized metal anchorage

Color : Graphite, Metallic Grey, Black
For corrosion resistance, zincrim applied to surface of the luminaire before electrostatic powder coating With LED driver

LED Tipi LED Type	Renk Isısı Color Temperature	Toplam Güç Total Power	Akım Current	Voltaj Voltage	Toplam Lümen Total Lumen
Middle Power LED	3000K	44W	116mA	220V AC	3810lm
Middle Power LED	4000K	44W	116mA	220V AC	4174lm

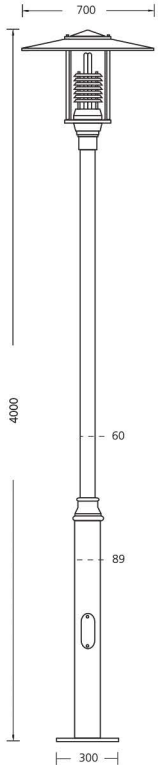

549L24

9ANK05

MIDDLE POWER LED



IP 65



549213



MAX.2x24W. TC-L 2G11



IYON

Malzeme : Üst başlık alüminyum enjeksiyon ve polikarbonat difüzör, alüminyum iç reflektör ve çelik boru direk gövdesi, galvanizli metal ankraj

Renk : Füme, Metalik Gri, Siyah

Armatürün yüzeyine elektrostatik toz boyadan önce korozyon direncini artırıcı zincoprım uygulanır. LED sürücüsü dahil

Material : Die-cast aluminium and polycarbonate diffuser upper head, aluminium inner reflector and pole body made of steel tube, galvanized metal anchorage

Color : Graphite, Metallic Grey, Black

For corrosion resistance, zincoprım applied to surface of the luminaire before electrostatic powder coating. With LED driver

LED Tipi LED Type	Renk Isısı Color Temperature	Toplam Güç Total Power	Akım Current	Voltaj Voltage	Toplam Lümen Total Lumen
Middle Power LED	3000K	44W	116mA	220V AC	3810lm
Middle Power LED	4000K	44W	116mA	220V AC	4174lm

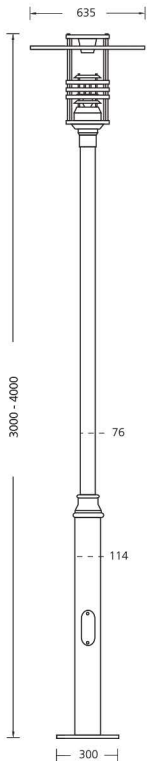

549L25

9ANK05

MIDDLE POWER LED



IP 65



549130



MAX.70W. HSE E27



Şehir Parkı - Karşıyaka / İZMİR



IYON

Malzeme : Üst başlık alüminyum enjeksiyon ve polikarbonat difüzör, alüminyum iç reflektör ve çelik boru direk gövdesi, galvanizli metal ankraj
Renk : Füme, Metalik Gri, Siyah
 Armatürün yüzeyine elektrostatik toz boyadan önce korozyon direncini artırıcı zincrim uygulanır. LED sürücüsü dahil

Material : Die-cast aluminium and polycarbonate diffuser upper head, aluminium inner reflector and pole body made of steel tube, galvanized metal anchorage
Color : Graphite, Metallic Grey, Black
 For corrosion resistance, zincrim applied to surface of the luminaire before electrostatic powder coating With LED driver

LED Tipi LED Type	Renk Isısı Color Temperature	Toplam Güç Total Power	Akım Current	Voltaj Voltage	Toplam Lümen Total Lumen
Middle Power LED	3000K	44W	116mA	220V AC	3810lm
Middle Power LED	4000K	44W	116mA	220V AC	4174lm

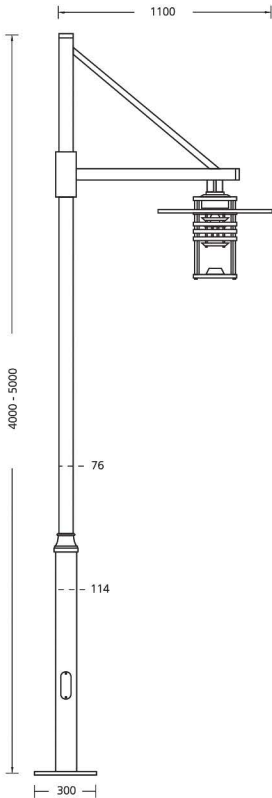

549L26

9ANK05

Ankraj / Anchorage

MIDDLE POWER LED



IP 65



549135



MAX.70W. HSE E27



IYON

Malzeme : Üst başlık alüminyum enjeksiyon ve polikarbonat difüzör, alüminyum iç reflektör ve çelik boru direk gövdesi, galvanizli metal ankraj
Renk : Füme, Metalik Gri, Siyah
 Armatürün yüzeyine elektrostatik toz boyadan önce korozyon direncini artırıcı zincrim uygulanır. LED sürücüsü dahil

Material : Die-cast aluminium and pycarbonate diffuser upper head, aluminium inner reflector and pole body made of steel tube, galvanized metal anchorage
Color : Graphite, Metallic Grey, Black
 For corrosion resistance, zincrim applied to surface of the luminaire before electrostatic powder coating With LED driver

LED Tipi LED Type	Renk Isısı Color Temperature	Toplam Güç Total Power	Akım Current	Voltaj Voltage	Toplam Lümen Total Lumen
Middle Power LED	3000K	2x44W	116mA	220V AC	2x3810lm
Middle Power LED	4000K	2x44W	116mA	220V AC	2x4174lm

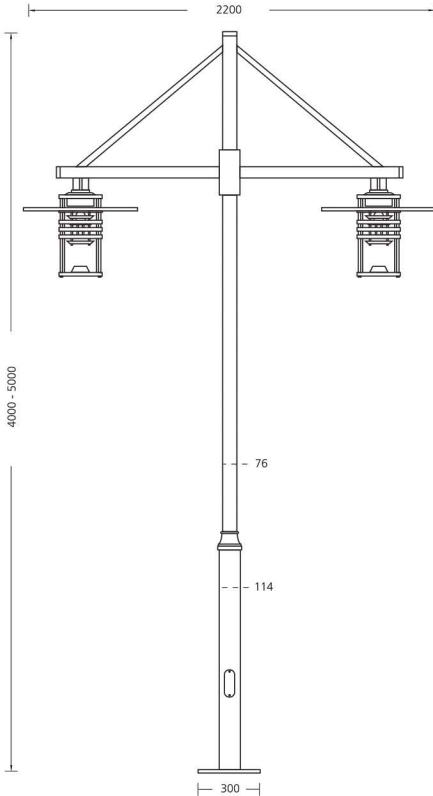

549L27

MIDDLE POWER LED

9ANK05

Ankraj / Anchorage



IP 65



549214



MAX.2x70W, HSE E27

FAGUS

Malzeme : Alüminyum profil ve enjeksiyon gövde, alüminyum reflektör ve akrilik difüzör,
galvanizli metal ankraj

Renk : Füme, Metalik Gri, Siyah
Armatürün yüzeyine elektrostatik toz boyadan önce korozyon direncini arttırıcı zincoprım uygulanır
LED sürücüsü dahil

Material : Die-cast aluminium and extruded body, aluminium reflector and acrylic diffuser,
galvanized metal anchorage

Color : Graphite, Metallic Grey, Black
For corrosion resistance, zincoprım applied to surface of the luminaire before electrostatic powder coating
With LED driver

LED Tipi LED Type	Renk Isısı Color Temperature	Toplam Güç Total Power	Akım Current	Voltaj Voltage	Toplam Lümen Total Lumen
Middle Power LED	3000K	51W	116mA	220V AC	5010lm
Middle Power LED	4000K	51W	116mA	220V AC	5205lm

**549L29****9ANK14**

MIDDLE POWER LED

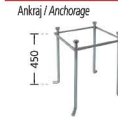

IP 65







MITRA

Malzeme : Alüminyum profil ve enjeksiyon gövde, akrilik difüzör, galvanizli metal ankraj
 Renk : Füme, Metalik Gri, Siyah
 Armatürün yüzeyine elektrostatik toz boyadan önce korozyon direncini arttırıcı zincrim uygulanır.
 LED sürücüsü dahil

Material : Die-cast aluminium and extruded body, acrylic diffuser, galvanized metal anchorage
 Color : Graphite, Metallic Grey, Black
 For corrosion resistance, zincrim applied to surface of the luminaire before electrostatic powder coating
 With LED driver

LED Tipi LED Type	Renk Isısı Color Temperature	Toplam Güç Total Power	Akım Current	Voltaj Voltage	Toplam Lümen Total Lumen
Power LED	3000K	4x82W	700mA	220V AC	4x7374lm
Power LED	4000K	4x82W	700mA	220V AC	4x8280lm
Power LED	6500K	4x82W	700mA	220V AC	4x9261lm

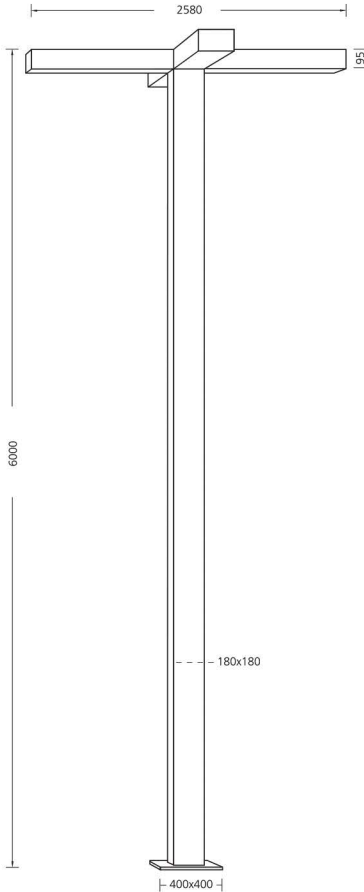

549L28

POWER LED

9ANK15

Ankraj / Anchorage



IP 65



CEDRUS

Malzeme : Alüminyum profil ve enjeksiyon gövde, alüminyum reflektör ve akrilik difüzör,
galvanizli metal ankraj
Renk : Füme, Metalik Gri, Siyah
Armatürün yüzeyine elektrostatik toz boyadan önce korozyon direncini arttırıcı zincoprim uygulanır
LED sürücüsü dahil

Material : Die-cast aluminium and extruded body, aluminium reflector and acrylic diffuser,
galvanized metal anchorage
Color : Graphite, Metallic Grey, Black
For corrosion resistance, zincoprim applied to surface of the luminaire before electrostatic powder coating
With LED driver

LED Tipi LED Type	Renk Isısı Color Temperature	Toplam Güç Total Power	Akım Current	Voltaj Voltage	Toplam Lümen Total Lumen
Middle Power LED	3000K	51W	116mA	220V AC	5010lm
Middle Power LED	4000K	51W	116mA	220V AC	5205lm

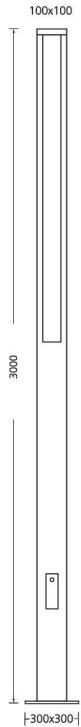

549L30

9ANK14

MIDDLE POWER LED

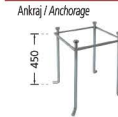

IP 65





Folkart - Bayraklı / İZMİR



Kefaluka - Bodrum / Muğla

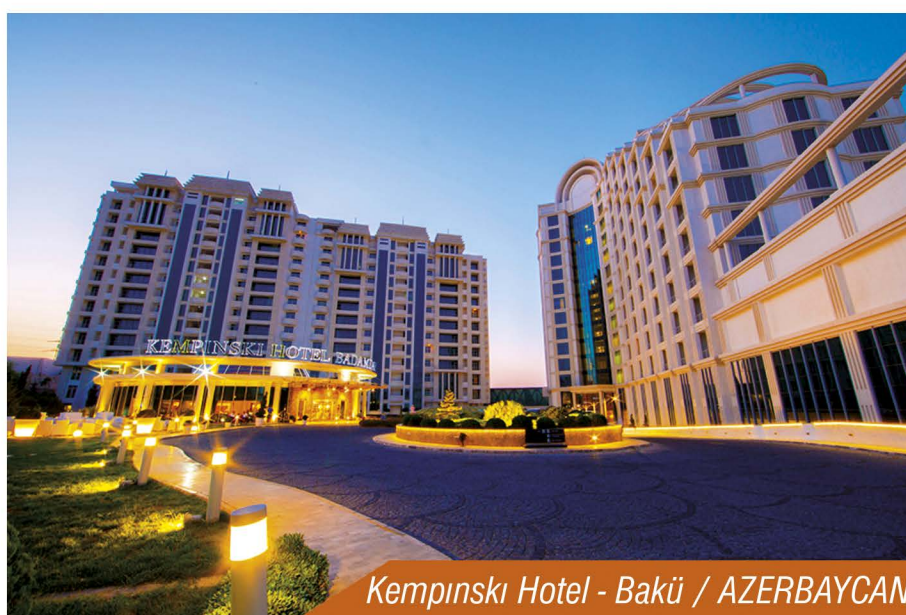

Kempinski Hotel - Bakü / AZERBAIJAN

ACIBADEM HASTANESİ - İSTANBUL	HEYBELİADA ORDUEVİ - İSTANBUL	NIKE TÜRKİYE MAĞAZALARI
AFYON İKBAL TESİSLERİ - AFYON	HILTON OTEL - BODRUM / MUĞLA	ORUÇOĞLU TERMAL OTEL - AFYON
AĞAOĞLU RESORT - İSTANBUL	HILTON OTEL - İZMİR	OSMAN GAZİ MÜFTÜLÜK BİNASI - BURSA
AK-KA İNŞAAT - İSTANBUL	HOLIDAY INN - ALMAATA / KAZAKİSTAN	ÖRSMARIS - MARMARIS / MUĞLA
ATATÜRK KÜLTÜR MERKEZİ - İZMİR	İZMİR BÜYÜKŞEHİR BELEDİYESİ	ÖZDİLEK AVM - BURSA
ALAÇATI BABYLON CLUB OTEL - ÇEŞME / İZMİR	İDEA YAPI A.Ş. - İZMİR	ÖZDİLEK AVM - İZMİR
ALAGURA SURF CENTER - ÇEŞME / İZMİR	İNGİLTERE BÜYÜKELÇİLİĞİ - ANKARA	ÖZEL AFYON HASTANESİ - AFYON
ALZER OTEL - SULTANAHMET / İSTANBUL	İTÜ AYAZAĞA YURT BİNASI - İSTANBUL	PALMİRA OTEL - ANTALYA
ANADOLU SERAMİKİSAN - ESKİŞEHİR	İTÜ MASLAK KAMPÜSÜ - İSTANBUL	PARK HYATT REGENCY - BAKÜ / AZERBAJYAN
ANEMON OTEL - MANİSA	İZAIR OTEL - İZMİR	PHILSA TORBALI TESİSLERİ EK BİNALAR - İZMİR
ALTINYUNUS OTEL - MARMARIS / MUĞLA	İZMİR ÜNİVERSİTESİ - İZMİR	PHILIP MORRIS MERKEZ YÖNETİM BİNASI - İZMİR
AVANOS DOUBLE TREE BY HILTON OTEL - NEVŞEHİR	CADDEBOSTAN KÜLTÜR MRK. - İSTANBUL	PORSCHE SHOWROOM - İZMİR
BURSA BÜYÜKŞEHİR BELEDİYESİ	İZMİR KEMALPAŞA BELEDİYESİ	QUEEN ADA RESORT - BODRUM
BAYRAM HALİL ARAKLI DEVLET HASTANESİ - TRABZON	KAPADOKYA LODGE OTEL - NEVŞEHİR	RADISSON SAS HOTEL - TRABLUS/LİBYA
BELÇİKA KONSOLOSLUĞU - İSTANBUL	KARŞIYAKA OPERA ve TİYATRO BİNASI - İZMİR	RADISSON SAS OTEL - SEFAKÖY/İSTANBUL
BELCONTI RESORT - ANTALYA	KARİNNA OTEL - İZMİR	REGNUM ASTRUM TOWERS - İSTANBUL
BORNOVA BELEDİYESİ KÜLTÜR VE NİKAH SARAYI - İZMİR	KEFALUKA OTEL - BODRUM / MUĞLA	RICHMOND OTEL - İSTANBUL
BRITISH TOBACCO FABRİKASI - BURSA	KEMERBURGAZ EVLERİ - İSTANBUL	ROBINSON CLUB OTEL - ANTALYA
BURSA BETON A.Ş. - BURSA	KEMERLİFE XXI - İSTANBUL	ROYAL MARMARIS OTEL - MUĞLA
RÖNESANS HOLDİNG PROJELERİ	KOCAELİ ÜNİVERSİTESİ - İZMİR	SARAR GİYİM - ESKİŞEHİR
CAPITAL FACTORİNG YÖNETİM BİNASI - İSTANBUL	KOCAPEPE ÜNİVERSİTESİ - AFYON	SASEL İNŞAAT - İSTANBUL
CARREFOUR MALTEPE - İSTANBUL	KORDON OTEL - İZMİR	SEVGİ HASTANESİ - BALIKESİR
BODRUM BELEDİYESİ	KOSİFLER OTO - İSTANBUL	SEYHAN PARK EVLERİ - ADANA
CORDIAL HOUSE OTEL - İSTANBUL	KİPA BALÇOVA AVM - İZMİR	SC BUTİK OTEL - İZMİR
ÇANAKKALE ŞEHİTLİĞİ - ÇANAKKALE	LA MASION - BEŞİKTAŞ / İSTANBUL	SHERATON OTEL - ANKARA
7800 OTEL - ÇEŞME / İZMİR	LARA FRESCO DONDURMA MĞZ. - İSTANBUL	SIRASELVLER URLA - İZMİR
DEDEMAN OTEL - BALMUMCU / İSTANBUL	LE PAIN QUOTIDIEN CAFELERİ - İSTANBUL	SOLTO OTEL - ÇEŞME / İZMİR
DEM OTO VOLKSWAGEN SHOWROOM - MANİSA	LOTUS EVLERİ - ORTAKÖY / İSTANBUL	SOYAK İNŞAAT - İSTANBUL
DİVAN RESİDANCE - İSTANBUL	LÖDER LÖSEMİLİ ÇOCUKLARA YARDIM DERNEĞİ - BURSA	SOYAK MAVİŞEHİR - İZMİR
DOĞU ELEKTRİK - İSTANBUL	MAGOSA BELEDİYESİ ÇEVRE AYD. - K.K.T.C.	SOYAK ZEYTİNALANI - İZMİR
DOĞUŞ OTO MERKEZ BİNASI - İSTANBUL	MARES OTEL - MARMARIS / MUĞLA	SOYAK OLİMPİYAKENT - İSTANBUL
DOKUZ EYLÜL ÜNİVERSİTESİ TIP FAKÜLTESİ - İZMİR	MARMARA FORUM AVM - İSTANBUL	STARBUCKS ŞUBELERİ - TÜRKİYE
DOKUZ EYLÜL ÜNİVERSİTESİ TINAZTEPE KAMPÜSÜ - İZMİR	MARRIOTT EXECUTİVE APARTMENTS - ATIRAU / KAZAKİSTAN	SİMPAŞ HOLDİNG TÜRKİYE PROJELERİ
DUMLUPINAR ÜNİVERSİTESİ FEN EDEBİYAT FAKÜLTESİ - AFYON	MARRIOTT OTEL - GÜRCİSTAN	SUNUCU PLAZA - İZMİR
EGE PALAS OTEL - İZMİR	MC DONALDS ŞUBELERİ - İSTANBUL	TEKFEN HOLDİNG YAPI GELİŞTİRME YALIKAVAK - BODRUM
EGE ÜNİVERSİTESİ REKREASYON ALANLARI - İZMİR	MEMORIAL HASTANESİ - İSTANBUL	TİCARET ODASI TESİSLERİ DİDİM - AYDIN
EKOL K.B.B. HASTANESİ - İZMİR	MERCEDES-BENZ HASAFYON - AFYON	TİKE RESTAURANT - BURSA
EKONOMİ ÜNİVERSİTESİ - İZMİR	MERCEDES-BENZ HASTALYA - ANTALYA	T.B.M.M. - ANKARA
ETİ BİSKÜVİ FABRİKASI - ESKİŞEHİR	MERİNOS KÜLTÜR PARK - BURSA	TOYOTA BOROVALI - İZMİR
ESKİDJİ SUİTES - İSTANBUL	MESA ÇENGELKÖY KONUTLARI - İSTANBUL	ÜRDÜN GENEL KURMAY BAŞKANLIĞI - ÜRDÜN
EURODEKOR KARABAĞLAR SHOWROOM - İZMİR	MESYAPI SEMİLYON KONAKLARI - ÇORLU	URLA KENT MEYDANI PROJESİ - İZMİR
FATİH BELEDİYESİ - İSTANBUL	MEHMET AKİF ERSOY ÜNİVERSİTESİ - BURDUR	XSUDU OTEL - BELEK / ANTALYA
FENERBAHÇE S.K. SAMANDRA TESİSLERİ - İSTANBUL	MIRA TOWERS - İSTANBUL	VODAFONE ŞUBELERİ - TÜRKİYE
FENERBAHÇE ORDUEVİ - İSTANBUL	MUĞLA ÜNİVERSİTESİ GÜZ. SAN. FAK. - BODRUM	YALIKAVAK MARİNA - BODRUM
GALATASARAY S.K. TESİSLERİ - İSTANBUL	MUĞLA ÜNİVERSİTESİ REKTÖRLÜK VE FEN FAK. - MUĞLA	YAPI MERKEZİ - İSTANBUL
GARANTİ AKKOZA - İSTANBUL	NİSH İSTANBUL - İSTANBUL	YASA DİNLENME TESİSLERİ - BALIKESİR
GÖKMAHAL RESİDENCE - İSTANBUL	AYDIN NAZİLLİ BELEDİYESİ	YAŞAR ÜNİVERSİTESİ - İZMİR
GRAND YAZICI BUTİK HOTEL - BODRUM / MUĞLA	NOVA OTEL - TRABZON	YATSAN MAĞAZALARI - TÜRKİYE
GÜNEŞLİ KONUTLARI - İSTANBUL	OBRECEVA KALUJSKAYA AVM - RUSYA	YILDIZ TEKNİK ÜNİVERSİTESİ
G PLUS SATIŞ OFİSİ - İSTANBUL	OKSİZEN KONAKLARI - İSTANBUL	YÜKSEK TEKNOLOJİ ÜNİVERSİTESİ ÇEVRE AYD. - İZMİR
HANTİ MANSİSKY KONUTLARI - RUSYA	ONMUŞ ELEKTRİK TAAHHÜT - İZMİR	YÜKSEK VADI EVLERİ - İZMİR

LAS

STiLAS

STiL

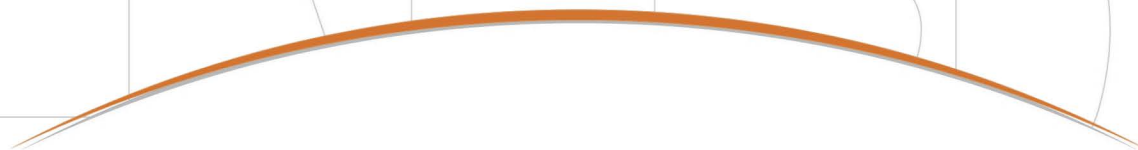

 **STiLAS**



STILAS